

HOUSING: **804S-4** - LOW PROFILE MULTI-LAMP LAMP MODULE: **J2S** or **K2S** | LED

Project Name	
Date	Type
Prepared By	
Comments	
Catalog # 804S-4 / - / / L1 - - -	
/ L2 - - - - / L3 - - - - / L4 - - - -	



526 Portal Street
Colton, CA 94931
USA
P 707.794.0888
www.8lighting.com

All No. 8 Lighting fixtures and components are UL Listed to both U.S. and Canadian requirements. No. 8 Lighting trims and lamp modules are protected by one or more U.S. Patents. No. 8 Lighting reserves the right to change details of design, materials, and finish.

© 2026 No. 8 Lighting
Doc # 91162-13.4



PRODUCT FEATURES

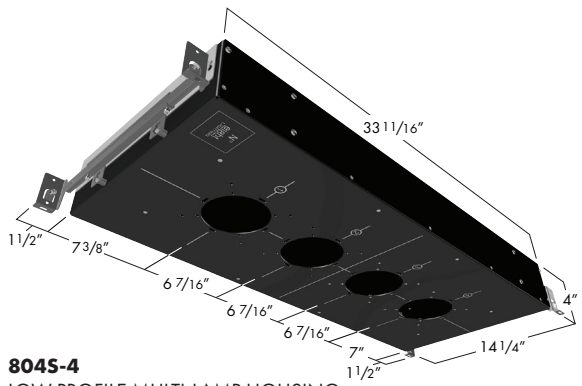

804S-4
LOW PROFILE MULTI-LAMP HOUSING
(shown with BH mounting accessory)



J2S - LED ADJUSTABLE



K2S - LED FIXED POSITION

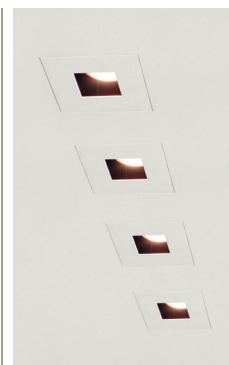

804S-4 with **FS-P** trim
(Specified separately)



804S-4 with **FR-P** trim
(Specified separately)

804S-4 SPECIFICATION SUMMARY

	Static White Standard Output			Warm Dimming			Tunable White
	HI	HI-2	HI-3	WD	WD-2	WD-4	TW
LED Option	HI	HI-2	HI-3	WD	WD-2	WD-4	TW
Delivered Lumens	4164	4176	3792	3348	3336	3472	4072
System Wattage	56	58	60	58	58	58	56
Efficacy	74	72	64	58	58	60	73
CRI	94	94	97	97	96	97	95
R9	60	63	98	82	77	76	79
CCT	2700K, 3000K			3000-1800K	2800-2200K	3000-2200K	4700-2200K
Optic Options	15, 25, 40	10	10, 15, 25, 40	15, 25, 40			15T, 25, 40
Color Consistency	2-Step			3-Step			
Optical Accessories	Narrow, Medium, Wide, Extra Wide, Linear Spread, and 2400K, 2700K, 3500K Color Filters						
Adjustability	J2S - 0-45° Tilt, 360° Rotation, Lockable / K2S - Fixed Position						
Driver Options	<1% Forward/Reverse Phase (120v), 0.1/1% 0-10v (120-277v), 0.1/1% DALI (120-277v), 0.1% DMX (120-277v), 0.1/1% EcoSystem (120 or 277v)						
Trim Options	Round/Square Flat, Round/Square Bevel, Round/Square Inset, Round/Square Wall-Wash						
Finish Options	White, Oil-Rubbed Bronze, Pewter, Satin Nickel, Black						
Trim Mounting Options	Flanged, Flangeless Sheetrock, Flangeless Wood						
Trim Accessories	UL Wet Listed and IP54 Rated Lens Options - Clear, Soft Focus, Wall-Wash						
Housing Options	New Construction: Type IC-CP Rated CCEA Approved Air-Tight						

Data shown for Qty. 4 J2S Lamp Modules with FS/FLS/INS-LG/NL trims.
Static White and Tunable White data shown for 3000K.
Warm Dimming data shown for 3000K and 2800K.
See Performance Summaries for additional information.
800 Series Trims specified separately.

PRODUCT SPECIFIER/PRODUCT ORDER NUMBER

804S-4

HOUSING

DRIVER OPTIONS

OUTPUT

MOUNTING ACCESSORIES

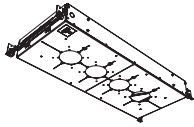

804S-4

New Construction -
Low Profile AIRTIGHT-IC
14 1/4"W x 33 11/16"L* x 4"H†

*Add 3" to length to accommodate mounting accessories.

†Minimum 4-1/2" ceiling space required when used with INSET and BEVEL Series trim assemblies.

- PR1-8**
Premium Forward or Reverse-Phase <1% Dimming
 - DMX1-8***
DMX 0.1% Dimming
 - DMX2-8****
2-channel DMX 0.1% Dimming
 - EL1-8†**
EldoLED 0-10v 1% Dimming
 - EL1-01-8†**
EldoLED 0-10v 0.1% Dimming
 - EL2-8†**
EldoLED DALI 1% Dimming
 - EL2-01-8†**
EldoLED DALI 0.1% Dimming
 - EL3-8****
EldoLED 2-channel DALI 0.1% Dimming
 - EL5-8****
EldoLED 2-channel 0-10v 0.1% Dimming
 - LU2-8**
Lutron Hi-Lume LDE1 Eco-System 1% Dimming
 - LU4-8**
Lutron Hi-Lume PEQOE EcoSystem 0.1% Dimming
- *Available with HI-3 LED options only.
** Available with TW LED option only.
†Also CE Certified with HI or HI-2 LED options.

- 350**
Standard output for HI-3, HI-3-27, WD, WD-2, or WD-4 LED Options
 - 700†**
Standard output for TW LED Option
 - 1000**
Standard output for HI, HI-2, HI-2, or HI-2-27 LED Options
- †For use with DMX2-8, EL3-8, or EL5-8 driver options only.

- BH**
Bar Hangers for joist mounting
- BB**
Butterfly Brackets for c-channel or bar mounting
- TBC-BH**
T-Bar Mounting Clips + Bar Hangers for T-Bar mounting
- PMB**
Panel Mounting Brackets (set of two) for direct mounting to wood panels

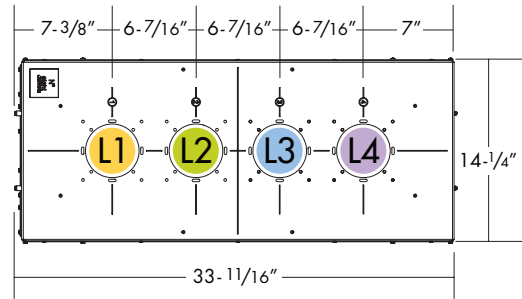

A combination Lamp Module, LED, Optic Option, and (optional) Optical Accessory is required for each lamp position. Lamp Modules can be intermixed within the same housing and are independently controllable.

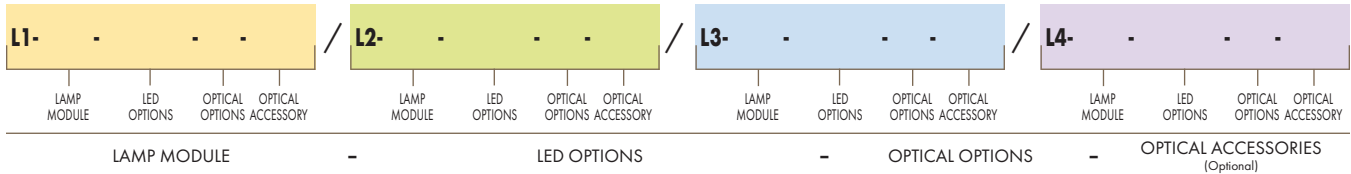

J25
LED ADJUSTABLE
45° tilt, full 360° rotation
with tool-less locking



K25
LED FIXED POSITION

- HI-27**
2700K White LED
- HI**
3000K White LED
- HI-2-27***
2700K White LED
- HI-2***
3000K White LED
- HI-3-27†**
2700K White High R9 LED
- HI-3†**
3000K White High R9 LED

- WD**
3000-1800K Warm Dim LED
- WD-2**
2800-2200K Warm Dim LED
- WD-4**
3000-2200K Warm Dim LED
- TW†**
4700-2200K Tunable White LED

- 10***
10° Very Narrow Spot
 - 15†**
15° Narrow Spot
 - 15T****
15° Narrow Spot-Tunable White
 - 25††**
25° Narrow Flood
 - 40††**
40° Flood
- *For use with HI-2 or HI-3 LED options only.
†For use with HI, HI-3, WD, WD-2, or WD-4 LED options only.
** For use with TW LED option only.
††Not for use with HI-2 LED options.

- NSP**
Narrow Softening Lens
 - NFL**
Medium Softening Lens
 - FL**
Wide Softening Lens
 - WFL**
Extra Wide Softening Lens
 - LS**
Linear Spread Softening Lens
 - CF24***
2400K Color Filtering Lens
 - CF27****
2700K Color Filtering Lens
 - CF35****
3500K Color Filtering Lens
- *For use with HI, HI-2, and HI-3 2700K LED options only.
** For use with HI, HI-2, and HI-3 3000K LED options only.

*For use with 10° optic only.
†Available with J25 Lamp Module only.

Housing and Installation Notes

804S-4 Low Profile AIRTIGHT IC-Rated for direct contact with standard or spray-foam thermal insulation with a max combined R-Value of R42 (may also be installed in Non-IC applications). Meets Washington State Airtight Standard WAC 51-11-0502 and in accordance with ASTM E283 to reduce energy loss. CCEA plenum rated for City of Chicago environmental air spaces. Ambient temperatures in ceiling space should not exceed 40°C (104°F) during normal operation. For models with **EL1-8**, **EL1-01-8**, **EL2-8**, **EL2-01-8**, or **LU2-8** dimming options, ambient temperatures should not exceed 25°C (77°F). Accepts four **J25** or **K25** LED Lamp Modules and four **800 Series** Trim Assemblies. For **800 Series** Trims (specified separately), see 8lighting.com/products-800-series-led.

Driver and Output Option Notes

0-10v and DMX driver options are configured for linear control. DALI driver options are configured for logarithmic control. No.8 Lighting conducts extensive testing to establish compatibility with many dimmer types. For a complete list of compatible dimmers, see 8lighting.com/resources-downloads. Outputs vary depending on LED type, trim type, and optical accessories used. For photometric files in PDF and IES formats, see 8lighting.com/800-series-photometry.

Lamp Module, LED, Optic Option, and Accessory Notes

J25 Fully adjustable lamp module features patented tool-free adjustment mechanism. Use for adjustable accent, wall wash*, and general lighting applications. *For wall washing: specify 40° optic option with **HI**, **HI-3**, **WD**, **WD-2**, **WD-4**, or **TW** LED or 10° optic option and **FL** lens with **HI-2** LED. Requires **WW-8** wall wash accessory, specified with **FS/FR** or **FLS/FLR** (1.75" aperture) **800 Series** trims. **K25** Fixed position lamp module for general lighting applications. To ensure fixture to fixture color consistency, use of the same LED option with adjacent fixtures is recommended. One field interchangeable optic option included standard. Up to two additional optical accessories can be accommodated.

Warranty

All No. 8 Lighting products are covered by a 5 year limited warranty. Products installed in residential steam applications are covered by a 2 year limited warranty. For specific warranty details and limitations, see 8lighting.com/resources-downloads.

JA8-2025 CA Title 24 Compliant.

804S-4/J2S w/ FS/FLS/INS 1.75" APERTURE TRIM - PERFORMANCE SUMMARY

LED	OUTPUT	CCT	CRI	R9	Delivered Lumens	System Wattage	Delivered LPW
HI-27	1000	2700K	94	59	2946-3530	56	53-63
HI	1000	3000K	94	60	3168-3796	56	57-68
HI-2-27	1000	2700K	94	62	3820	58	66
HI-2	1000	3000K	94	63	4108	58	71
HI-3-27	350	2700K	97	96-98	2664-3244	60	45-55
HI-3	350	3000K	97	96-98	2864-3488	60	49-59
WD	350	3000-1800K	97	82	2408-2940	58	42-51
WD-2	350	2800-2200K	96	78	2392-2924	58	41-50
WD-4	350	3000-2200K	96	76	2592-3068	58	45-53
TW	700	4700-2200K	95	79	2688-3772	56	48-67

Performance summary for HI LED with 15°, 25°, and 40° optic options, HI-2 LED with 10° optic option, and HI-3 LED with 10°, 15°, 25°, and 40° optic options.

Performance summary for WD and WD-4 LED at 3000K and WD-2 LED at 2800K with 15°, 25°, and 40° optic options.

Performance summary for TW LED at 3000K with 15°, 25°, and 40° optic options.

804S-4/J2S w/ FR/FLR/INR 1.75" APERTURE TRIM - PERFORMANCE SUMMARY

LED	OUTPUT	CCT	CRI	R9	Delivered Lumens	System Wattage	Delivered LPW
HI-27	1000	2700K	94	59	2857-3501	56	51-63
HI	1000	3000K	94	60	3072-3764	56	55-67
HI-2-27	1000	2700K	94	62	3783	58	65
HI-2	1000	3000K	94	63	4068	58	70
HI-3-27	350	2700K	97	96-98	2584-3216	60	44-55
HI-3	350	3000K	97	96-98	2780-3460	60	48-59
WD	350	3000-1800K	97	81	2400-2956	58	41-51
WD-2	350	2800-2200K	97	77	2380-2956	58	41-51
WD-4	350	3000-2200K	97	76	2512-3000	58	43-52
TW	700	4700-2200K	95	79	2580-3672	56	46-66

Performance summary for HI LED with 15°, 25°, and 40° optic options, HI-2 LED with 10° optic option, and HI-3 LED with 10°, 15°, 25°, and 40° optic options.

Performance summary for WD and WD-4 LED at 3000K and WD-2 LED at 2800K with 15°, 25°, and 40° optic options.

Performance summary for TW LED at 3000K with 15°, 25°, and 40° optic options.

804S/J2S w/ 1.75" APERTURE TRIM - OPTICAL OPTIONS AND ACCESSORY PERFORMANCE SUMMARY

OPTIC OPTIONS	LED OPTIONS	BEAM ENHANCING LENS (OPTIONAL)*				
		+ NSP	+ NFL	+ FL	+ WFL	+ LS
10° Very Narrow Spot	HI-2	14°	25°	44°	47°	13° x 39°
10° Very Narrow Spot	HI-3	14°	23°	40°	46°	14° x 41°
15° Narrow Spot	HI	21°	30°	45°	51°	21° x 40°
15° Narrow Spot	HI-3	17°	26°	42°	50°	17° x 43°
15° Narrow Spot	WD/WD-2/WD-4	24°	31°	36°	50°	25° x 41°
15° Narrow Spot	TW	21°	27°	37°	38°	25° x 30°
25° Narrow Flood	HI	28°	34°	47°	52°	30° x 39°
25° Narrow Flood	HI-3	24°	30°	47°	52°	24° x 49°
25° Narrow Flood	WD/WD-2/WD-4	29°	34°	46°	52°	32° x 38°
25° Narrow Flood	TW	28°	37°	46°	50°	29° x 43°
40° Flood	HI	41°	43°	43°	59°	40° x 52°
40° Flood	HI-3	33°	37°	49°	54°	32° x 51°
40° Flood	WD/WD-2/WD-4	37°	40°	49°	54°	37° x 47°
40° Flood	TW	37°	40°	49°	54°	36° x 48°

*Beam enhancing lens used in combination with 10°, 15°, 25°, or 40° optic to achieve desired beam spread.

804S/J2S w/ FS/FLS/INS 1.75" APERTURE TRIM - CONE OF LIGHT DIAGRAMS

STANDARD OUTPUT	10° - Very Narrow Spot 804S/J2S-HI-2-10/1000	15° - Narrow Spot 804S/J2S-HI-15/1000	25° - Narrow Flood 804S/J2S-HI-25/1000	40° - Flood 804S/J2S-HI-40/1000
	2ft - 3,938 fc Ø0.4 ft 4ft - 985 fc Ø0.8 ft 6ft - 438 fc Ø1.2 ft 8ft - 246 fc Ø1.5 ft 10ft - 158 fc Ø1.9 ft CBCP: 15,774 cd	2ft - 1,426 fc Ø0.7 ft 4ft - 356 fc Ø1.3 ft 6ft - 158 fc Ø2.0 ft 8ft - 89 fc Ø2.6 ft 10ft - 57 fc Ø3.3 ft CBCP: 5,723 cd	2ft - 736 fc Ø1.0 ft 4ft - 184 fc Ø1.9 ft 6ft - 82 fc Ø2.9 ft 8ft - 46 fc Ø3.9 ft 10ft - 29 fc Ø4.8 ft CBCP: 2,952 cd	2ft - 435 fc Ø1.5 ft 4ft - 109 fc Ø3.0 ft 6ft - 48 fc Ø4.4 ft 8ft - 27 fc Ø5.9 ft 10ft - 17 fc Ø7.4 ft CBCP: 1,739 cd
STANDARD OUTPUT - HI-3	10° - Very Narrow Spot 804S/J2S-HI-3-10/350 2ft - 3,109 fc Ø0.4 ft 4ft - 777 fc Ø0.9 ft 6ft - 345 fc Ø1.3 ft 8ft - 194 fc Ø1.7 ft 10ft - 124 fc Ø2.2 ft CBCP: 12,463 cd	15° - Narrow Spot 804S/J2S-HI-3-15/350 2ft - 1,922 fc Ø0.7 ft 4ft - 481 fc Ø1.1 ft 6ft - 214 fc Ø1.6 ft 8ft - 120 fc Ø2.2 ft 10ft - 77 fc Ø3.7 ft CBCP: 7,747 cd	25° - Narrow Flood 804S/J2S-HI-3-25/350 2ft - 917 fc Ø0.8 ft 4ft - 229 fc Ø1.6 ft 6ft - 102 fc Ø2.4 ft 8ft - 57 fc Ø3.3 ft 10ft - 37 fc Ø4.1 ft CBCP: 3,675 cd	40° - Flood 804S/J2S-HI-3-40/350 2ft - 545 fc Ø1.2 ft 4ft - 136 fc Ø2.4 ft 6ft - 61 fc Ø3.5 ft 8ft - 34 fc Ø4.7 ft 10ft - 22 fc Ø5.9 ft CBCP: 2,183 cd
STANDARD OUTPUT - WARM DIM		15° - Narrow Spot 804S/J2S-WD-15/350 2ft - 871 fc Ø0.8 ft 4ft - 218 fc Ø1.6 ft 6ft - 97 fc Ø2.4 ft 8ft - 54 fc Ø3.3 ft 10ft - 35 fc Ø4.1 ft CBCP: 3,498 cd	25° - Narrow Flood 804S/J2S-WD-25/350 2ft - 533 fc Ø1.0 ft 4ft - 133 fc Ø2.0 ft 6ft - 59 fc Ø3.1 ft 8ft - 33 fc Ø4.1 ft 10ft - 21 fc Ø5.1 ft CBCP: 2,136 cd	40° - Flood 804S/J2S-WD-40/350 2ft - 401 fc Ø1.3 ft 4ft - 100 fc Ø2.6 ft 6ft - 45 fc Ø4.0 ft 8ft - 25 fc Ø5.3 ft 10ft - 16 fc Ø6.6 ft CBCP: 1,605 cd
STANDARD OUTPUT - TUNABLE WHITE		15° - Narrow Spot 804S/J2S-TW-15T/700 2ft - 1,730 fc Ø0.8 ft 4ft - 432 fc Ø1.5 ft 6ft - 192 fc Ø2.3 ft 8ft - 108 fc Ø3.1 ft 10ft - 69 fc Ø3.9 ft CBCP: 6,919 cd	25° - Narrow Flood 804S/J2S-TW-25/700 2ft - 606 fc Ø1.0 ft 4ft - 152 fc Ø2.0 ft 6ft - 67 fc Ø3.0 ft 8ft - 38 fc Ø4.0 ft 10ft - 24 fc Ø5.0 ft CBCP: 2,424 cd	40° - Flood 804S/J2S-TW-40/700 2ft - 430 fc Ø1.3 ft 4ft - 108 fc Ø2.7 ft 6ft - 48 fc Ø4.0 ft 8ft - 27 fc Ø5.4 ft 10ft - 17 fc Ø6.7 ft CBCP: 1,722 cd

Note: Performance shown for individual lamp modules at 3000K. Output varies by CCT.

804S-4/J2S w/ FS/FLS/INS-LG/NL 2.75" APERTURE TRIM - PERFORMANCE SUMMARY

LED	OUTPUT	CCT	CRI	R9	Delivered Lumens	System Wattage	Delivered LPW
HI-27	1000	2700K	94	59	3352-3873	56	60-69
HI	1000	3000K	94	60	3604-4164	56	64-74
HI-2-27	1000	2700K	94	62	3884	58	67
HI-2	1000	3000K	94	63	4176	58	72
HI-3-27	350	2700K	97	96-98	3040-3532	60	52-60
HI-3	350	3000K	97	96-98	3268-3796	60	56-64
WD	350	3000-1800K	97	82	2908-3348	58	50-58
WD-2	350	2800-2200K	96	77	2912-3336	58	50-58
WD-4	350	3000-2200K	97	76	3076-3468	58	53-60
TW	700	4700-2200K	95	79	3212-4072	56	57-73

Performance summary for HI LED with 15°, 25°, and 40° optic options, HI-2 LED with 10° optic option, and HI-3 LED with 10°, 15°, 25°, and 40° optic options.
 Performance summary for WD and WD-4 LED at 3000K and WD-2 LED at 2800K with 15°, 25°, and 40° optic options.
 Performance summary for TW LED at 3000K with 15°, 25°, and 40° optic options.

804S-4/J2S w/ FR/FLR/INR-LG/NL 2.75" APERTURE TRIM - PERFORMANCE SUMMARY

LED	OUTPUT	CCT	CRI	R9	Delivered Lumens	System Wattage	Delivered LPW
HI-27	1000	2700K	94	59	3385-3902	56	60-70
HI	1000	3000K	94	60	3640-4196	56	65-75
HI-2-27	1000	2700K	94	62	3902	58	72
HI-2	1000	3000K	94	63	4196	58	72
HI-3-27	350	2700K	97	96-98	3064-3424	60	52-58
HI-3	350	3000K	97	96-98	3296-3680	60	56-62
WD	350	3000-1800K	97	81	2980-3448	58	51-59
WD-2	350	2800-2200K	97	77	2964-3396	58	51-59
WD-4	350	3000-2200K	97	76	3088-3472	58	53-60
TW	700	4700-2200K	95	79	3176-4136	56	57-74

Performance summary for HI LED with 15°, 25°, and 40° optic options, HI-2 LED with 10° optic option, and HI-3 LED with 10°, 15°, 25°, and 40° optic options.
 Performance summary for WD and WD-4 LED at 3000K and WD-2 LED at 2800K with 15°, 25°, and 40° optic options.
 Performance summary for TW LED at 3000K with 15°, 25°, and 40° optic options.

804S/J2S w/ 2.75" APERTURE TRIM - OPTICAL OPTIONS AND ACCESSORY PERFORMANCE SUMMARY

OPTIC OPTIONS	LED OPTIONS	BEAM ENHANCING LENS (OPTIONAL)*				
		+ NSP	+ NFL	+ FL	+ WFL	+ LS
10° Very Narrow Spot	HI-2	14°	24°	43°	47°	13° x 39°
10° Very Narrow Spot	HI-3	14°	24°	48°	58°	14° x 51°
15° Narrow Spot	HI	21°	31°	54°	67°	22° x 48°
15° Narrow Spot	HI-3	17°	27°	51°	62°	17° x 51°
15° Narrow Spot	WD/WD-2/WD-4	24°	33°	54°	66°	26° x 48°
15° Narrow Spot	TW	23°	30°	48°	54°	27° x 34°
25° Narrow Flood	HI	29°	37°	57°	71°	30° x 55°
25° Narrow Flood	HI-3	24°	32°	55°	65°	25° x 60°
25° Narrow Flood	WD/WD-2/WD-4	31°	38°	58°	70°	70° x 71°
25° Narrow Flood	TW	30°	37°	57°	69°	31° x 53°
40° Flood	HI	42°	45°	46°	80°	41° x 63°
40° Flood	HI-3	34°	35°	62°	71°	34° x 65°
40° Flood	WD/WD-2/WD-4	39°	44°	64°	77°	76° x 77°
40° Flood	TW	38°	43°	63°	76°	37° x 61°

*Beam enhancing lens used in combination with 10°, 15°, 25°, or 40° optic to achieve desired beam spread.

804S/J2S w/ FS/FLS/INS-LG/NL 2.75" APERTURE TRIM - CONE OF LIGHT DIAGRAMS

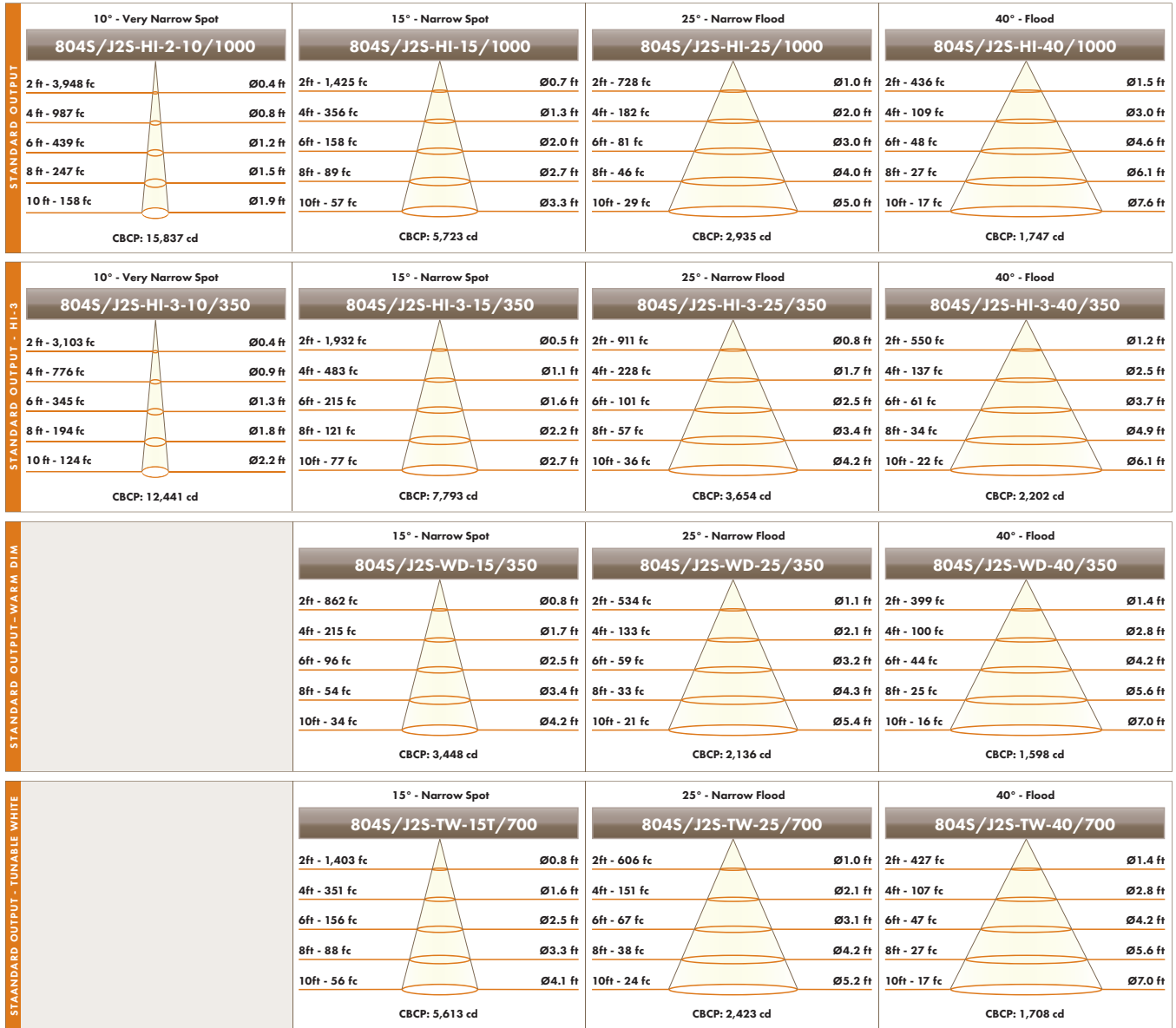

Note: Performance shown for individual lamp modules at 3000K. Output varies by CCT.

804S-4/K2S w/ FS/FLS/INS 1.75" APERTURE TRIM - PERFORMANCE SUMMARY

LED	OUTPUT	CCT	CRI	R9	Delivered Lumens	System Wattage	Delivered LPW
HI-27	1000	2700K	94	59	3415-3969	56	61-71
HI	1000	3000K	94	60	3672-4268	56	66-76
HI-2-27	1000	2700K	94	62	4100	58	71
HI-2	1000	3000K	94	63	4408	58	76
WD	350	3000-1800K	97	81	2960-3484	58	51-60
WD-2	350	2800-2200K	97	78	2956-3444	58	51-59
WD-4	350	3000-2200K	97	76	3152-3664	58	54-63

Performance summary for HI LED with 15°, 25°, and 40° optic options and HI-2 LED with 10° optic option.
 Performance summary for WD and WD-4 LED at 3000K and WD-2 LED at 2800K with 15°, 25°, and 40° optic options.

804S-4/K2S w/ FR/FLR/INR 1.75" APERTURE TRIM - PERFORMANCE SUMMARY

LED	OUTPUT	CCT	CRI	R9	Delivered Lumens	System Wattage	Delivered LPW
HI-27	1000	2700K	94	59	3396-3917	56	61-70
HI	1000	3000K	94	60	3652-4212	56	65-75
HI-2-27	1000	2700K	94	62	4060	58	70
HI-2	1000	3000K	94	63	4364	58	75
WD	350	3000-1800K	97	81	3028-3568	58	52-62
WD-2	350	2800-2200K	97	78	2972-3508	58	51-60
WD-4	350	3000-2200K	97	76	3100-3556	58	53-61

Performance summary for HI LED with 15°, 25°, and 40° optic options and HI-2 LED with 10° optic option.
 Performance summary for WD and WD-4 LED at 3000K and WD-2 LED at 2800K with 15°, 25°, and 40° optic options.

804S/K2S w/ FS/FLS/INS 1.75" APERTURE TRIM - CONE OF LIGHT DIAGRAMS

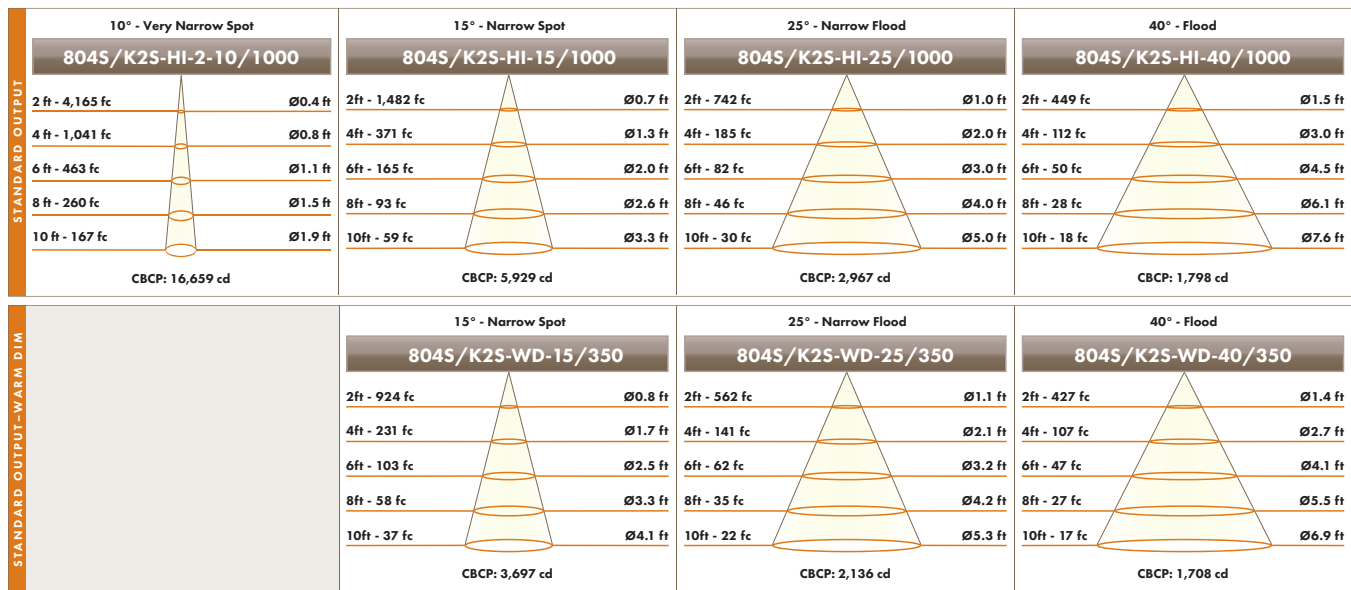

Note: Performance shown for individual lamp modules at 3000K. Output varies by CCT.

804S-4/K2S w/ FS/FLS/INS-LG/NL 2.75" APERTURE TRIM - PERFORMANCE SUMMARY

LED	OUTPUT	CCT	CRI	R9	Delivered Lumens	System Wattage	Delivered LPW
HI-27	1000	2700K	94	59	3698-4166	56	66-74
HI	1000	3000K	94	60	3976-4480	56	71-80
HI-2-27	1000	2700K	94	62	4200	58	72
HI-2	1000	3000K	94	63	4516	58	78
WD	350	3000-1800K	97	81	3284-3692	58	57-64
WD-2	350	2800-2200K	97	78	3276-3660	58	56-63
WD-4	350	3000-2200K	97	76	3444-3856	58	59-66

Performance summary for HI LED with 15°, 25°, and 40° optic options and HI-2 LED with 10° optic option.
Performance summary for WD and WD-4 LED at 3000K and WD-2 LED at 2800K with 15°, 25°, and 40° optic options.

804S-4/K2S w/ FR/FLR/INR-LG/NL 2.75" APERTURE TRIM - PERFORMANCE SUMMARY

LED	OUTPUT	CCT	CRI	R9	Delivered Lumens	System Wattage	Delivered LPW
HI-27	1000	2700K	94	59	3701-4207	56	66-75
HI	1000	3000K	94	60	3980-4524	56	71-81
HI-2-27	1000	2700K	94	62	4155	58	72
HI-2	1000	3000K	94	63	4468	58	77
WD	350	3000-1800K	97	81	3412-3828	58	59-66
WD-2	350	2800-2200K	97	78	3352-3728	58	58-64
WD-4	350	3000-2200K	97	76	3452-3812	58	59-66

Performance summary for HI LED with 15°, 25°, and 40° optic options and HI-2 LED with 10° optic option.
Performance summary for WD and WD-4 LED at 3000K and WD-2 LED at 2800K with 15°, 25°, and 40° optic options.

804S/K2S w/ FS/FLS/INS-LG/NL 2.75" APERTURE TRIM - CONE OF LIGHT DIAGRAMS

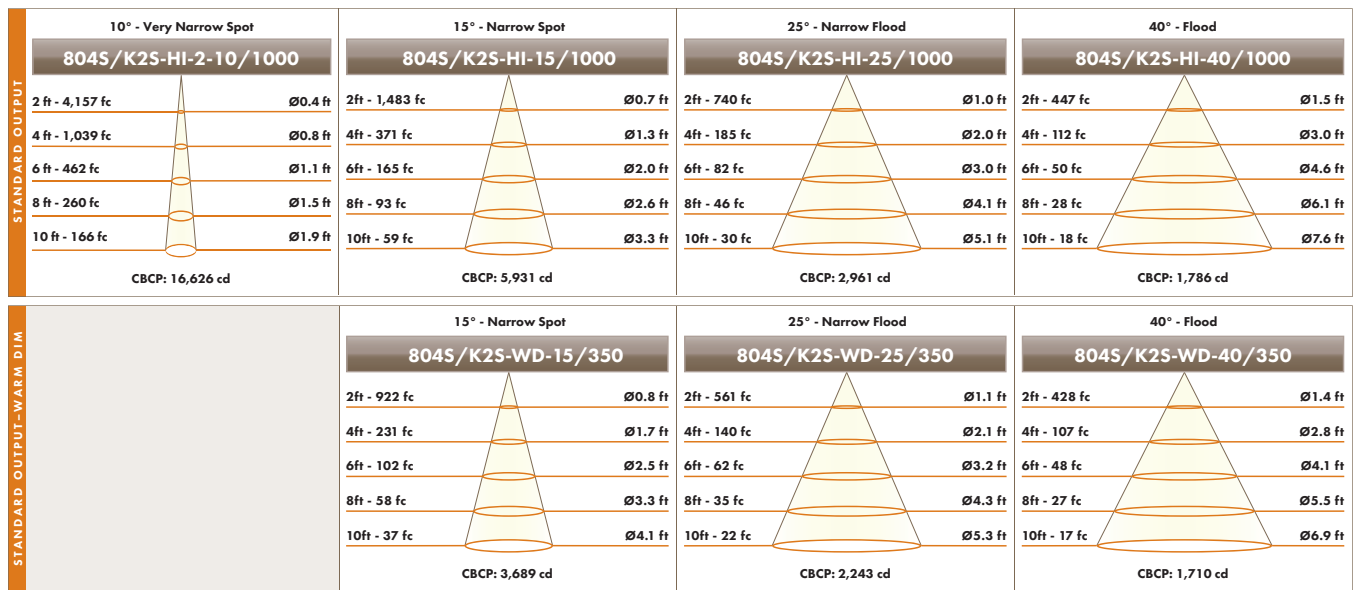

804S-4/J2S w/ FS/FLS-WW-8 1.75" APERTURE TRIM - PERFORMANCE SUMMARY

LED	OUTPUT	OPTIC OPTION	CCT	CRI	R9	Delivered Lumens	System Wattage	Delivered LPW
HI-27	1000	40	2700K	94	57	2466	56	44
HI	1000	40	3000K	94	58	2652	56	47
HI-2-27	1000	10-FL	2700K	94	61	1882	58	32
HI-2	1000	10-FL	3000K	94	62	2024	58	35
HI-3-27	350	40	2700K	97	98	2256	60	38
HI-3	350	40	3000K	97	98	2424	60	41
WD	350	40	3000-1800K	97	83	2128	58	37
WD-2	350	40	2800-2200K	97	78	2112	58	36
WD-4	350	40	3000-2200K	97	76	2220	58	38
TW	700	40	4700-2200K	96	80	2272	56	41

Performance summary for TW, WD, and WD-4 LED at 3000K and WD-2 LED at 2800K.

804S/J2S-HI-40/1000 w/ FS/FLS TRIM + WW-8 WALL WASH ACCESSORY – FOOTCANDLES ON WALL

DISTANCE TO WALL		2.0 ft						2.5 ft						
		ON CENTER SPACING			2.0 ft			2.5 ft		2.5 ft			3.0 ft	
	DISTANCE FROM CEILING	0.5 ft	1.0	1.1	1.0	0.9	0.8	0.9	0.3	0.3	0.3	0.3	0.2	0.3
		1.5 ft	27.3	31.0	27.3	25.1	25.0	25.1	13.4	14.8	13.4	12.6	12.1	12.6
		2.5 ft	28.0	32.6	28.0	25.2	28.8	25.2	19.6	22.8	19.6	18.1	20.0	18.1
		3.5 ft	18.4	20.8	18.4	16.7	19.3	16.7	16.1	18.7	16.1	14.8	17.2	14.8
		4.5 ft	11.3	12.4	11.3	10.5	11.8	10.5	11.2	12.7	11.2	10.4	12.0	10.4
		5.5 ft	7.1	7.6	7.1	6.7	7.3	6.7	7.6	8.4	7.6	7.1	8.0	7.1
		6.5 ft	4.6	4.9	4.6	4.4	4.8	4.4	5.2	5.6	5.2	4.9	5.4	4.9
		7.5 ft	3.1	3.3	3.1	3.0	3.2	3.0	3.6	3.9	3.6	3.5	3.8	3.5
		8.5 ft	2.2	2.3	2.2	2.2	2.3	2.2	2.6	2.8	2.6	2.5	2.7	2.5
		9.5 ft	1.6	1.7	1.6	1.6	1.6	1.6	1.9	2.0	1.9	1.9	2.0	1.9

Note: With HI LED option, use 40° optic and 20° aiming angle for optimal performance. Data shown for individual lamp modules at 3000K. Output varies by CCT.

804S/J2S-WD-40/350 w/ FS/FLS TRIM + WW-8 WALL WASH ACCESSORY – FOOTCANDLES ON WALL

DISTANCE TO WALL		2.0 ft						2.5 ft						
		ON CENTER SPACING			2.0 ft			2.5 ft		2.5 ft			3.0 ft	
	DISTANCE FROM CEILING	0.5 ft	1.1	1.4	1.1	1.0	0.9	1.0	0.3	0.4	0.3	0.3	0.3	0.3
		1.5 ft	21.8	25.5	21.8	19.8	20.3	19.8	10.5	12.0	10.5	9.7	9.8	9.7
		2.5 ft	23.8	28.4	23.8	21.2	24.9	21.2	16.3	19.5	16.3	14.9	17.0	14.9
		3.5 ft	16.0	18.2	16.0	14.4	16.9	14.4	13.8	16.3	13.8	12.6	14.9	12.6
		4.5 ft	9.8	10.8	9.8	9.1	10.3	9.1	11.1	11.1	11.1	9.0	10.5	9.0
		5.5 ft	6.2	6.6	6.2	5.8	6.4	5.8	7.3	7.3	7.3	6.2	7.0	6.2
		6.5 ft	4.0	4.2	4.0	3.8	4.1	3.8	4.9	4.9	4.9	4.3	4.7	4.3
		7.5 ft	2.7	2.8	2.7	2.7	2.8	2.7	3.4	3.4	3.4	3.0	3.3	3.0
		8.5 ft	1.9	2.0	1.9	1.9	2.0	1.9	2.4	2.4	2.4	2.2	2.4	2.2
		9.5 ft	1.4	1.4	1.4	1.4	1.4	1.4	1.7	1.8	1.7	1.6	1.7	1.6

Note: With WD, WD-2, or WD-4 LED option, use 40° optic and 20° aiming angle for optimal performance. Data shown for individual lamp modules at 3000K. Output varies by CCT.

804S-4/J2S w/ FR/FLR-WW-8 1.75" APERTURE TRIM - PERFORMANCE SUMMARY

LED	OUTPUT	OPTIC OPTION	CCT	CRI	R9	Delivered Lumens	System Wattage	Delivered LPW
HI-27	1000	40	2700K	94	57	2180	56	39
HI	1000	40	3000K	94	58	2344	56	42
HI-2-27	1000	10-FL	2700K	94	61	1681	58	29
HI-2	1000	10-FL	3000K	94	62	1808	58	31
HI-3-27	350	40	2700K	97	98	2052	60	35
HI-3	350	40	3000K	97	98	2208	60	38
WD	350	40	3000-1800K	97	83	1916	58	33
WD-2	350	40	2800-2200K	97	78	1920	58	33
WD-4	350	40	3000-2200K	97	78	2024	58	35
TW	700	40	4700-2200K	96	79	2088	56	37

Performance summary for TW, WD, and WD-4 LED at 3000K and WD-2 LED at 2800K.

804S/J2S-HI-40/1000 w/ FR/FLR TRIM + WW-8 WALL WASH ACCESSORY – FOOTCANDLES ON WALL

DISTANCE TO WALL		2.0 ft						2.5 ft						
		ON CENTER SPACING			2.0 ft			2.5 ft		2.5 ft			3.0 ft	
	DISTANCE FROM CEILING	0.5 ft	0.8	0.8	0.8	0.8	0.5	0.8	0.2	0.2	0.2	0.2	0.2	0.2
		1.5 ft	25.1	29.1	25.1	22.8	23.2	22.8	12.1	13.6	12.1	11.3	10.9	11.3
		2.5 ft	26.4	31.0	26.4	23.7	27.1	23.7	18.2	21.4	18.2	16.7	18.7	16.7
		3.5 ft	17.7	20.2	17.7	16.0	18.7	16.0	15.3	17.9	15.3	14.0	16.3	14.0
		4.5 ft	10.9	12.0	10.9	10.1	11.4	10.1	10.8	12.3	10.8	10.0	11.6	10.0
		5.5 ft	6.8	7.3	6.8	6.4	7.1	6.4	7.3	8.1	7.3	6.9	7.8	6.9
		6.5 ft	4.4	4.7	4.4	4.2	4.6	4.2	5.0	5.4	5.0	4.7	5.2	4.7
		7.5 ft	3.0	3.1	3.0	2.9	3.1	2.9	3.5	3.7	3.5	3.3	3.6	3.3
		8.5 ft	2.1	2.2	2.1	2.0	2.1	2.0	2.5	2.6	2.5	2.4	2.6	2.4
		9.5 ft	1.5	1.6	1.5	1.5	1.5	1.5	1.8	1.9	1.8	1.8	1.9	1.8

Note: With HI LED option, use 40° optic and 20° aiming angle for optimal performance. Data shown for individual lamp modules at 3000K. Output varies by CCT.

804S/J2S-WD-40/350 w/ FR/FLR TRIM + WW-8 WALL WASH ACCESSORY – FOOTCANDLES ON WALL

DISTANCE TO WALL		2.0 ft						2.5 ft						
		ON CENTER SPACING			2.0 ft			2.5 ft		2.5 ft			3.0 ft	
	DISTANCE FROM CEILING	0.5 ft	1.1	1.0	1.1	1.0	0.7	1.0	0.4	0.3	0.4	0.3	0.2	0.3
		1.5 ft	19.3	21.6	19.3	17.5	17.5	17.5	9.1	10.0	9.1	8.5	8.1	8.5
		2.5 ft	22.1	25.3	22.1	19.7	22.3	19.7	14.8	16.8	14.8	13.5	14.6	13.5
		3.5 ft	15.3	17.1	15.3	13.7	16.0	13.7	13.0	14.8	13.0	11.8	13.5	11.8
		4.5 ft	9.5	10.3	9.5	8.7	9.9	8.7	9.3	10.4	9.3	8.6	9.9	8.6
		5.5 ft	6.0	6.4	6.0	5.6	6.2	5.6	6.4	7.0	6.4	6.0	6.7	6.0
		6.5 ft	3.9	4.1	3.9	3.7	4.0	3.7	4.4	4.7	4.4	4.2	4.6	4.2
		7.5 ft	2.6	2.7	2.6	2.5	2.7	2.5	3.1	3.2	3.1	2.9	3.2	2.9
		8.5 ft	1.9	1.9	1.9	1.8	1.9	1.8	2.2	2.3	2.2	2.1	2.3	2.1
		9.5 ft	1.3	1.4	1.3	1.3	1.4	1.3	1.6	1.7	1.6	1.6	1.7	1.6

Note: With WD, WD-2, or WD-4 LED option, use 40° optic and 20° aiming angle for optimal performance. Data shown for individual lamp modules at 3000K. Output varies by CCT.