

400-R/400-R-RT REMODEL ADJUSTABLE LED FLS-4 and FLR-4 FLANGED TRIMS



eight
LIGHTING

526 Portal Street
Cotati, CA 94931
USA
P 707.794.0888
www.8lighting.com

All No. 8 Lighting fixtures and components are UL Listed to both U.S. and Canadian requirements. No. 8 Lighting trims and lamp modules are protected by one or more U.S. Patents. No. 8 Lighting reserves the right to change details of design, materials, and finish.

© 2025 No. 8 Lighting
Doc # 91260-13.3



Project Name	
Date	Type
Prepared By	
Comments	
Catalog #	- - - / - - / - -

PRODUCT FEATURES



400-R
REMODEL LIGHT ENGINE and
INTEGRAL POWER SUPPLY
AIRTIGHT and IC RATED



400-R-RT
REMODEL LIGHT ENGINE for
REMOTE POWER SUPPLY
AIRTIGHT and IC RATED



400 SERIES TRIMS
FLANGED for SHEETROCK/WOOD/STONE



400-R/400-R-RT w/ FLANGED TRIM - SPECIFICATION SUMMARY



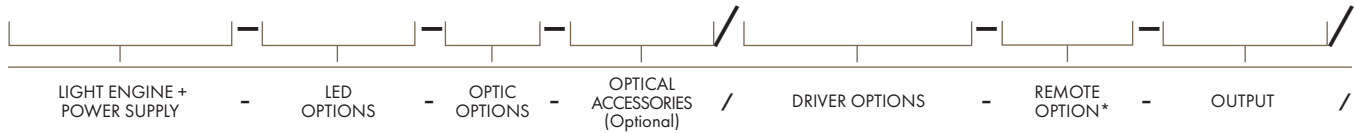

LED Option	Static White		Warm Dimming		
	HI	HI-2	WD	WD-2	WD-4
Delivered Lumens	1037	1082	818	809	864
System Wattage	14	14.5	15	15	15
Efficacy	74	75	56	55	59
CRI	94	94	97	97	97
R9	60	63	82	78	76
CCT Options	2700K, 3000K		3000-1800K	2800-2200K	3000-2200K
Optic Options	15, 25, 40	10	15, 25, 40		
Color Consistency	2-Step		3-Step		
Optical Accessories	Narrow, Medium, Wide, Extra Wide, Linear Spread, and 2400K, 2700K, 3500K Color Filters				
Adjustability	0-35° Tilt, 360° Rotation, Lockable				
Driver Options	INTEGRAL: <1% Forward/Reverse Phase (120v), 0.1/1% 0-10v (120-277v), 0.1/1% DALI (120-277v), 0.1/1% EcoSystem (120 or 277v) REMOTE: <1% Forward/Reverse Phase (120v), 0.1/1% 0-10v (120-277v), 0.1/1% DALI (120-277v), 1% EcoSystem (120 or 277v)				
Trim Options	Round/Square Flat				
Finish Options	White, Oil-Rubbed Bronze				
Trim Mounting Options	Flanged: Sheetrock/Wood/Stone Ceiling Applications				
Trim Accessories	UL Wet Listed Lens Options - Clear, Soft Focus, Wall Wash				
Mounting Options	Remodel: Type IC Air-Tight				

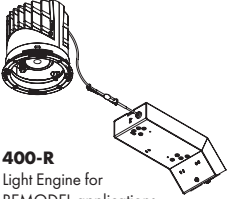
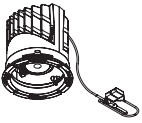
Performance data shown with FLS-4 Trim.
Static White data shown for 3000K.
Warm Dimming data shown for 3000K and 2800K.
See Performance Summaries for additional information.

PRODUCT SPECIFIER/PRODUCT ORDER NUMBER



 <p>400-R Light Engine for REMODEL applications with INTEGRAL power supply. AIRTIGHT and IC Rated. Adjustable LED with 0-35° Tilt and 360° Rotation.</p>  <p>400-R-RT Light Engine for REMODEL applications with REMOTE power supply. AIRTIGHT and IC Rated. Adjustable LED with 0-35° Tilt and 360° Rotation.</p>	<p>HI-27 2700K White LED HI 3000K White LED HI-2-27* 2700K White LED HI-2* 3000K White LED WD 3000-1800K Warm Dim LED WD-2 2800-2200K Warm Dim LED WD-4 3000-2200K Warm Dim LED *For use with 10° optic only.</p>	<p>10* 10° Very Narrow Spot 15 15° Narrow Spot 25 25° Narrow Flood 40 40° Flood *For use with HI-2 LED options only.</p>	<p>NSP Narrow Softening Lens NFL Medium Softening Lens FL Wide Softening Lens WFL Extra Wide Softening Lens LS Linear Spread Softening Lens CF24* 2400K Color Filtering Lens CF27** 2700K Color Filtering Lens CF35** 3500K Color Filtering Lens *For use with HI and HI-2 2700K LED options only. **For use with HI and HI-2 3000K LED options only.</p>	<p>PR1-4-R Premium Forward or Reverse-Phase <1% Dimming EL1-4-R EldoLED 0-10v 1% Dimming EL1-01-4-R EldoLED 0-10v 0.1% Dimming EL2-4-R EldoLED DALI 1% Dimming EL2-01-4-R EldoLED 0.1% DALI Dimming LU2-4-R Lutron Hi-Lume LDE1 EcoSystem 1% Dimming LU4-4-R* Lutron Hi-Lume PEQ0E EcoSystem 0.1% Dimming *Not available with RT remote option.</p>	 <p>RT REMOTE Mounted Power Supply *For use with 400-R-RT light engine only. Leave blank for integral dimming options.</p>	<p>350 Standard output for WD, WD-2, or WD-4 LED Options. 1000 Standard output for HI, HI-27, HI-2, or HI-2-27 LED Options.</p>
--	--	--	---	---	--	---

<p>FLS-4 5" SQUARE Flanged Flat Trim Plate with 2" Aperture</p>  <p>FLR-4 5" ROUND Flanged Flat Trim Plate with 2" Aperture</p> 	<p>WH WHITE</p>  <p>OB* OIL-RUBBED BRONZE *Specialty finish.</p> 	<p>CL4* CLEAR lens SF4* SOFT FOCUS lens WW-4* WALL WASH accessory *UL Wet listed.</p>
--	---	--

Maximum REMOTE Driver-to-LED Light Engine Wire Length				
Driver Model				Wire Gauge
PR1/EL1/EL1-01/EL2/EL2-01-4-R	LU2-4-R	LU2-4-R		
RT-1000/RT-350	RT-350	RT-1000		
8 ft (2.5 m)		4 ft (1.2 m)		24 AWG (0.2 mm ²)
13 ft (4 m)		6 ft (1.8 m)		22 AWG (0.34 mm ²)
20 ft (6 m)		10 ft (3 m)		20 AWG (0.5 mm ²)
30 ft (9 m)		15 ft (4.5 m)		18 AWG (.75 mm ²)
35 ft (10.5 m)		25 ft (7.5 m)		16 AWG (1.5 mm ²)
50 ft (15 m)		40 ft (12 m)		14 AWG (2.5 mm ²)
100 ft (30 m)		60 ft (18 m)		12 AWG (4.0 mm ²)
Wire Type: Stranded Class 2 wire (supplied by others)				

Light Engine Options and Installation Notes
400-R/400-R-RT Fully adjustable Airtight and IC-Rated light engine for REMODEL applications features patented tool-free adjustment mechanism. **400-R** for use with INTEGRAL power supply and **400-R-RT** for use with REMOTE mounted power supply. Use for adjustable accent, wall wash, and general lighting applications. Meets Washington State Airtight Standard WAC 51-11-0502 and in accordance with ASTM E283 to reduce energy loss. Accommodates a wide range of ceiling thicknesses without affecting aiming or adjustment. For installations in direct contact with thermal insulation, ambient temperatures in ceiling space should not exceed 25°C (77°F) during normal operation. For installations where insulation is held back a minimum of 3" from sides and top, ambient temperatures in ceiling space should not exceed 40°C (104°F) during normal operation.

LED, Optic Option, and Accessory Notes
 For wall washing: specify 40° optic option with **HI**, **WD**, **WD-2** or **WD-4** LED, or 10° optic option and **FL** lens with **HI-2** LED. Requires **WW-4** wall wash accessory. To ensure fixture to fixture color consistency, use of the same LED option with adjacent fixtures is recommended. One field interchangeable optic option included standard. Up to two additional optical accessories can be accommodated.

Driver and Output Option Notes
 0-10v driver options are configured for linear control. DALI driver options are configured for logarithmic control. No.8 Lighting conducts extensive testing to establish compatibility with many dimmer types. For a complete list of compatible dimmers, see 8lighting.com/resources-downloads. Outputs vary depending on LED type, trim type, and optical accessories used. For photometric files in PDF and IES formats, see: 8lighting.com/400-series-photometry.

Trim Finish Notes
 White trim finish is field paintable to match ceiling color. Lot variations may occur with specialty finishes. Ordering ALL trim kits at the same time is recommended to minimize finish variations.

Trim Accessory Notes
 Trim lens accessories are factory installed into trim plates and are UL WET LISTED and rated for use in DRY, DAMP, or WET locations (covered ceiling applications only). Approved for use in residential steam applications. Not for use in commercial steam applications.

Warranty
 All No. 8 Lighting products are covered by a 5 year limited warranty. Products installed in residential steam applications are covered by a 2 year limited warranty. For specific warranty details and limitations, see: 8lighting.com/resources-downloads.

JAB-2025 CA Title 24 Compliant.

400-R/400-R-RT FIXTURE ASSEMBLY with FLS-4/FLR-4 FLANGED TRIM - REMODEL MOUNTING

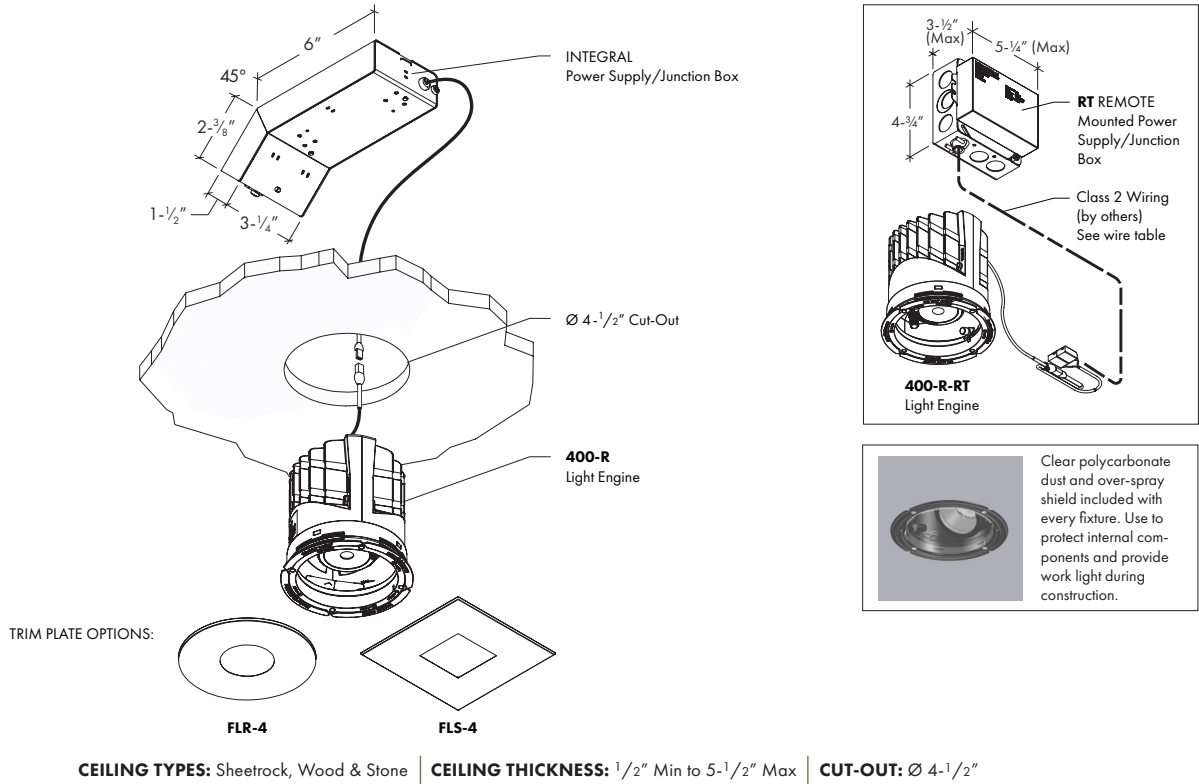

400-R/400-R-RT FIXTURE ASSEMBLY with FLS-4/FLR-4 FLANGED TRIM - REMODEL MOUNTING

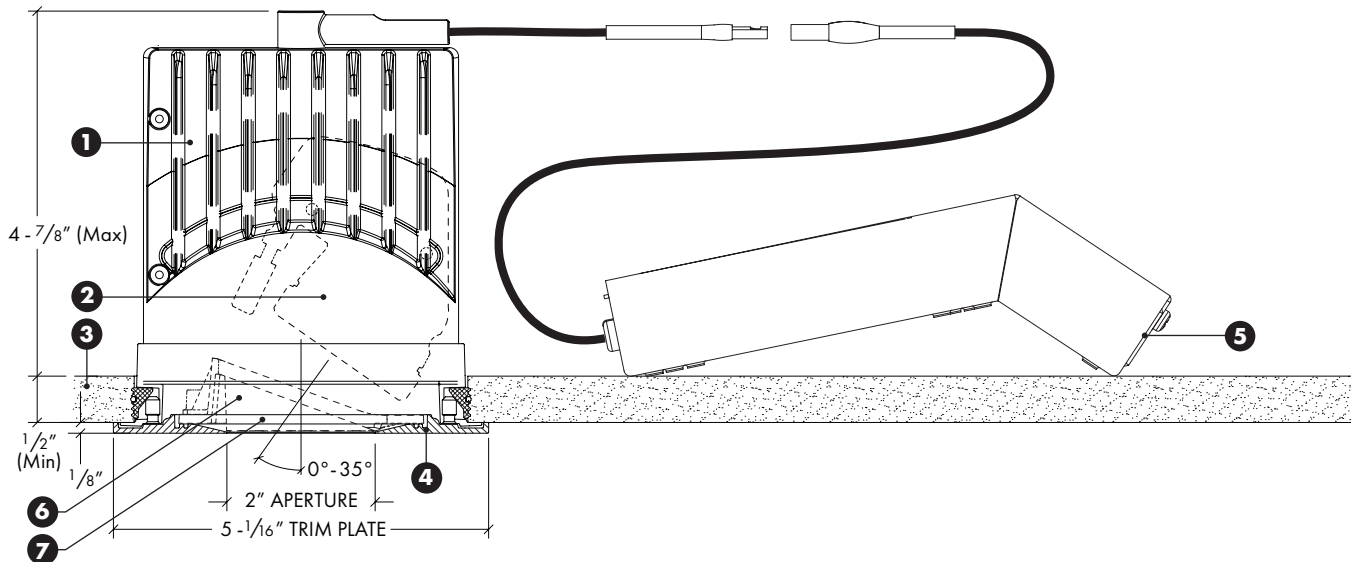

- 1) **400-R/400-R-RT REMODEL Light Engine** Airtight + IC Rated installs from below finished ceiling into 4-1/2" cut-out.
- 2) **Adjustable LED & Optics** Features 0°- 35° tilt and 360° rotation with tool-less locking.
- 3) **Ceiling Material** (sheetrock/wood/stone) Accommodates ceiling thicknesses from 1/2" (min) to 5-1/2" (max) without affecting aiming or rotation. Ceiling material must be rigid and able to support weight of fixture (approximately 5lbs.). Not for use with Acoustic tile or non-rigid ceiling materials.
- 4) **FLS-4/FLR-4 Flanged Flat Trim Plate** Features unique magnetic attachment with minimal flange overlap.
- 5) **Integral Power Supply/Junction Box** (shown) Installs from below finished ceiling and is accessible after installation. **RT Remote Power Supply/Junction Box** (not shown) can be mounted up to 100ft from fixture using 12AWG Class 2 stranded wire. See wire length table.
- 6) **WW-4 Wall Wash Accessory Lens** (optional) - Factory installed into trim plate. UL WET LISTED for use in DRY, DAMP, or WET locations (covered ceiling applications only). Approved for use in residential steam applications. Not for use in commercial steam applications.
- 7) **CL4/SF4 Clear/Soft Focus Accessory Lens** (optional) - Factory installed into trim plate. UL WET LISTED for use in DRY, DAMP, or WET locations (covered ceiling applications only). Approved for use in residential steam applications. Not for use in com-mercial steam applications.

400 SERIES w/ FLS-4 TRIM - PERFORMANCE SUMMARY

LED	OUTPUT	CCT	CRI	R9	Delivered Lumens	System Wattage	Delivered LPW
HI-27	1000	2700K	94	60	819-964	14	59-69
HI	1000	3000K	94	60	881-1037	14	63-74
HI-2-27	1000	2700K	94	63	1006	14.5	69
HI-2	1000	3000K	94	63	1082	14.5	75
WD	350	3000-1800K	97	82	694-818	15	48-56
WD-2	350	2800-2200K	97	78	686-809	15	47-55
WD-4	350	3000-2200K	97	78	732-864	15	50-59

Performance summary for HI LED with 15°, 25°, and 40° optic options and HI-2 LED with 10° optic option.
Performance summary for WD and WD-4 LED at 3000K and WD-2 LED at 2800K with 15°, 25°, and 40° optic options.

400 SERIES w/ FLR-4 TRIM - PERFORMANCE SUMMARY

LED	OUTPUT	CCT	CRI	R9	Delivered Lumens	System Wattage	Delivered LPW
HI-27	1000	2700K	94	60	811-955	14	58-68
HI	1000	3000K	94	60	872-1027	14	62-73
HI-2-27	1000	2700K	94	63	1004	14.5	69
HI-2	1000	3000K	94	63	1080	14.5	74
WD	350	3000-1800K	97	81	708-840	15	48-58
WD-2	350	2800-2200K	97	78	700-835	15	48-57
WD-4	350	3000-2200K	97	76	721-855	15	49-58

Performance summary for HI LED with 15°, 25°, and 40° optic options and HI-2 LED with 10° optic option.
Performance summary for WD and WD-4 LED at 3000K and WD-2 LED at 2800K with 15°, 25°, and 40° optic options.

400 SERIES w/ FLS-4 TRIM + WW-4 WALL WASH ACCESSORY - PERFORMANCE SUMMARY

LED	OUTPUT	CCT	CRI	R9	Delivered Lumens	System Wattage	Delivered LPW
HI-27	1000	2700K	94	60	652	14	47
HI	1000	3000K	94	60	701	14	50
HI-2-27	1000	2700K	94	64	504	14.5	35
HI-2	1000	3000K	94	64	542	14.5	37
WD	350	3000-1800K	97	82	548	15	38
WD-2	350	2800-2200K	97	80	543	15	37
WD-4	350	3000-2200K	97	78	580	15	40

Performance summary for HI LED with 40° optic option and HI-2 LED with 10° optic + FL lens option.
Performance summary for WD and WD-4 LED at 3000K and WD-2 LED at 2800K with 40° optic option.

400 SERIES w/ FLR-4 TRIM + WW-4 WALL WASH ACCESSORY - PERFORMANCE SUMMARY

LED	OUTPUT	CCT	CRI	R9	Delivered Lumens	System Wattage	Delivered LPW
HI-27	1000	2700K	94	60	659	14	47
HI	1000	3000K	94	60	709	14	51
HI-2-27	1000	2700K	94	64	509	14.5	35
HI-2	1000	3000K	94	64	547	14.5	38
WD	350	3000-1800K	97	82	584	15	40
WD-2	350	2800-2200K	97	80	560	15	38
WD-4	350	3000-2200K	97	77	587	15	40

Performance summary for HI LED with 40° optic option and HI-2 LED with 10° optic + FL lens option.
Performance summary for WD and WD-4 LED at 3000K and WD-2 LED at 2800K with 40° optic option.

400 SERIES - OPTICAL OPTIONS AND ACCESSORY PERFORMANCE SUMMARY

OPTIC OPTIONS	LED OPTIONS	BEAM ENHANCING LENS (OPTIONAL)*				
		+ NSP	+ NFL	+ FL	+ WFL	+ LS
10° Very Narrow Spot	HI-2	14°	25°	41°	44°	14° x 26°
15° Narrow Spot	HI	21°	30°	48°	56°	21° x 35°
15° Narrow Spot	WD/WD-2/WD-4	24°	32°	49°	56°	24° x 46°
25° Narrow Flood	HI	28°	35°	51°	59°	29° x 47°
25° Narrow Flood	WD/WD-2/WD-4	29°	35°	51°	58°	31° x 44°
40° Flood	HI	41°	44°	59°	66°	42° x 53°
40° Flood	WD/WD-2/WD-4	37°	42°	55°	62°	39° x 50°

*Beam enhancing lens used in combination with 10°, 15°, 25°, or 40° optic to achieve desired beam spread.

400 SERIES w/ FLS-4 TRIM - CONE OF LIGHT DIAGRAMS

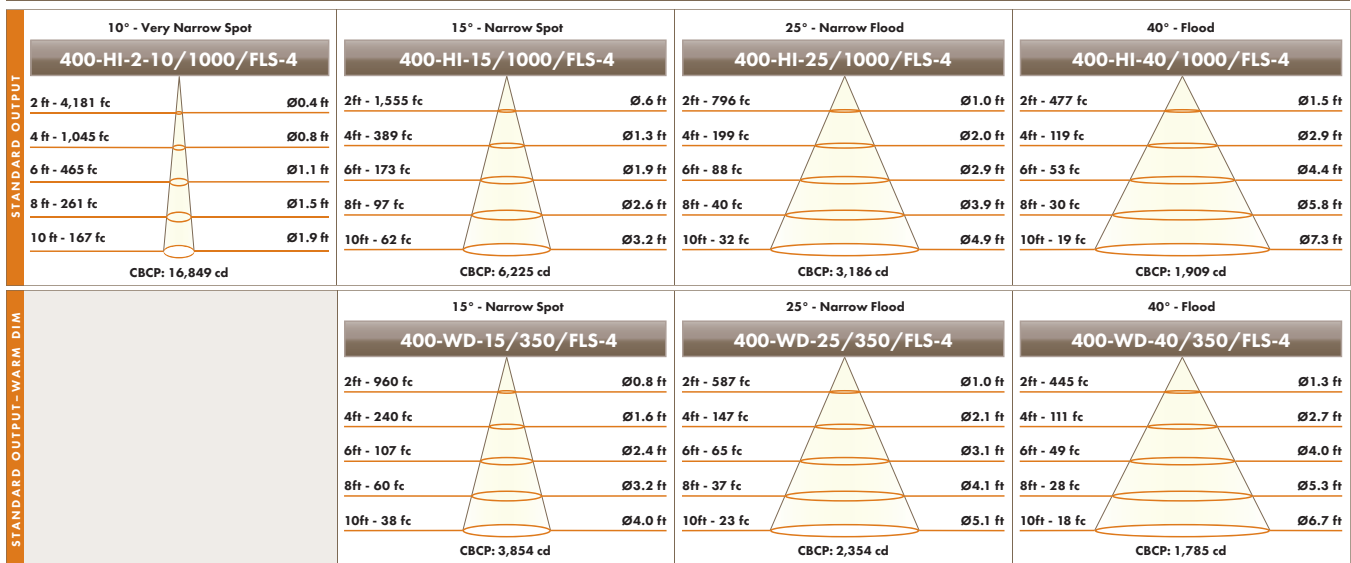

Performance shown for 3000K. Output varies by CCT.

400 SERIES w/ FLR-4 TRIM - CONE OF LIGHT DIAGRAMS

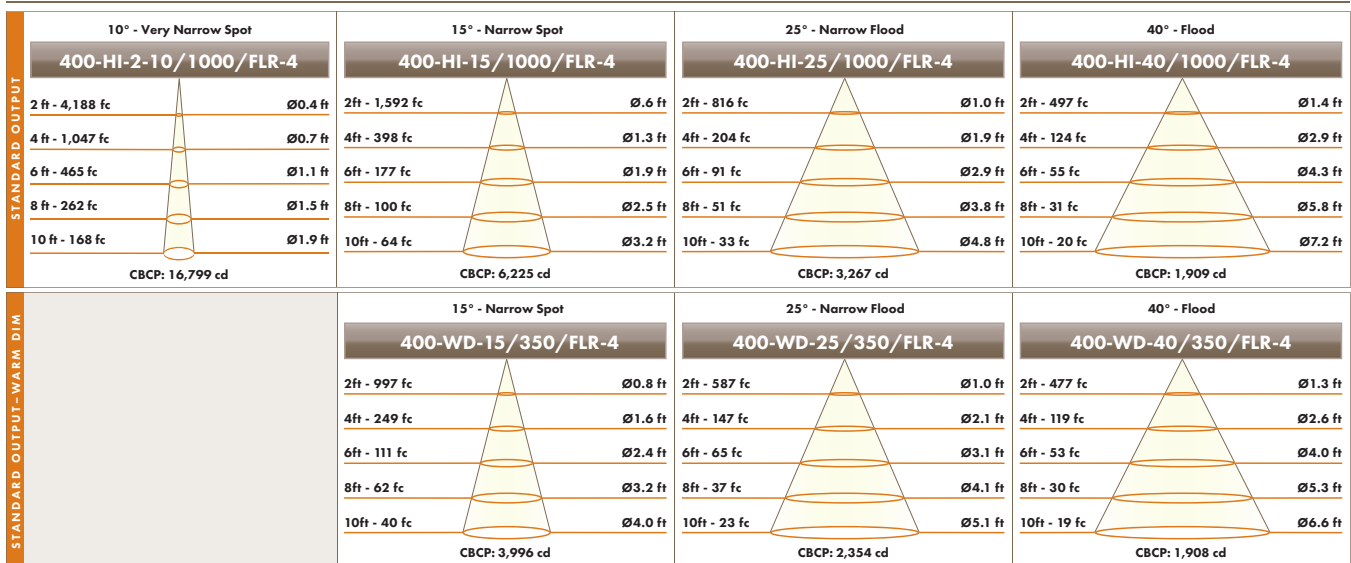

Performance shown for 3000K. Output varies by CCT.

400-HI-40 w/ FLS-4 TRIM + WW-4 WALL WASH ACCESSORY - FOOTCANDLES ON WALL

DISTANCE TO WALL		2.0 ft						2.5 ft						
ON CENTER SPACING			2.0 ft			2.5 ft			2.5 ft			3.0 ft		
	DISTANCE FROM CEILING	0.5 ft	0.4	3.0	0.4	0.4	0.2	0.4	0.1	0.1	0.1	0.1	0.1	0.1
		1.5 ft	28.9	31.1	28.9	25.8	25.3	25.8	13.3	13.9	13.3	12.1	11.3	12.1
		2.5 ft	32.7	36.4	32.7	29.2	32.3	29.2	22.2	24.3	22.2	20.2	21.5	20.2
		3.5 ft	21.9	23.8	21.9	19.9	22.4	19.9	19.0	21.1	19.0	17.3	19.6	17.3
		4.5 ft	13.3	14.2	13.3	12.5	13.6	12.5	13.3	14.5	13.3	12.4	13.8	12.4
		5.5 ft	8.3	8.7	8.3	7.9	8.4	7.9	9.0	9.6	9.0	8.5	9.2	8.5
		6.5 ft	5.4	5.6	5.4	5.2	5.5	5.2	6.1	6.4	6.1	5.8	6.3	5.8
		7.5 ft	3.6	3.7	3.6	3.5	3.7	3.5	4.2	4.4	4.2	4.1	4.3	4.1
		8.5 ft	2.6	2.6	2.6	2.5	2.6	2.5	3.0	3.2	3.0	3.0	3.1	3.0
		9.5 ft	1.9	1.9	1.9	1.8	1.9	1.8	2.2	2.3	2.2	2.2	2.3	2.2

Note: With HI LED option, use 40° optic and 20° aiming angle for optimal performance. Data shown for 3000K CCT.

400-HI-2-10-FL w/ FLS-4 TRIM + WW-4 WALL WASH ACCESSORY - FOOTCANDLES ON WALL

DISTANCE TO WALL		2.0 ft						2.5 ft						
ON CENTER SPACING			2.0 ft			2.5 ft			2.5 ft			3.0 ft		
	DISTANCE FROM CEILING	0.5 ft	0.4	0.4	0.4	0.4	0.3	0.4	0.1	0.1	0.1	0.1	0.1	0.1
		1.5 ft	18.3	19.3	18.3	16.7	14.9	16.7	7.5	7.6	7.5	7.0	5.9	7.0
		2.5 ft	23.7	26.3	23.7	21.2	22.8	21.2	15.4	17.0	15.4	14.1	14.6	14.1
		3.5 ft	16.7	18.2	16.7	15.1	16.7	15.1	14.0	15.5	14.0	12.8	14.1	12.8
		4.5 ft	10.5	11.2	10.5	9.8	10.6	9.8	10.2	11.1	10.2	9.5	10.4	9.5
		5.5 ft	6.7	7.0	6.7	6.3	6.7	6.3	7.0	7.5	7.0	6.6	7.2	6.6
		6.5 ft	4.3	4.5	4.3	4.2	4.4	4.2	4.9	5.1	4.9	4.6	4.9	4.6
		7.5 ft	3.0	3.0	3.0	2.9	3.0	2.9	3.4	3.6	3.4	3.3	3.5	3.3
		8.5 ft	2.1	2.1	2.1	2.0	2.1	2.0	2.5	2.5	2.5	2.4	2.5	2.4
		9.5 ft	1.5	1.5	1.5	1.5	1.5	1.5	1.8	1.9	1.8	1.8	1.8	1.8

Note: With HI-2 LED option, use 10° optic + FL lens and 20° aiming angle for optimal performance. Data shown for 3000K CCT.

400-WD-40 w/ FLS-4 TRIM + WW-4 WALL WASH ACCESSORY - FOOTCANDLES ON WALL

DISTANCE TO WALL		2.0 ft						2.5 ft						
ON CENTER SPACING			2.0 ft			2.5 ft			2.5 ft			3.0 ft		
	DISTANCE FROM CEILING	0.5 ft	0.2	0.2	0.2	0.2	0.1	0.2	0.1	0.1	0.1	0.1	0.1	
		1.5 ft	17.0	18.6	17.0	15.4	15.0	15.4	7.2	7.5	7.2	6.8	6.1	6.8
		2.5 ft	22.9	26.3	22.9	20.5	23.0	20.5	14.3	16.2	14.3	13.1	14.1	13.1
		3.5 ft	17.0	19.4	17.0	15.2	17.9	15.2	13.8	16.0	13.8	12.6	14.6	12.6
		4.5 ft	10.9	12.0	10.9	10.0	11.4	10.0	10.4	11.9	10.4	9.6	11.2	9.6
		5.5 ft	7.0	7.5	7.0	6.5	7.2	6.5	7.3	8.1	7.3	6.8	7.8	6.8
		6.5 ft	4.6	4.8	4.6	4.4	4.7	4.4	5.1	5.5	5.1	4.8	5.3	4.8
		7.5 ft	3.1	3.3	3.1	3.0	3.2	3.0	3.6	3.8	3.6	3.4	3.7	3.4
		8.5 ft	2.2	2.3	2.2	2.1	2.2	2.1	2.6	2.7	2.6	2.5	2.7	2.5
		9.5 ft	1.6	1.7	1.6	1.6	1.6	1.6	1.9	2.0	1.9	1.9	2.0	1.9

Note: With WD, WD-2, or WD-4 LED option, use 40° optic and 20° aiming angle for optimal performance. Data shown for 3000K CCT.

400-HI-40 w/ FLR-4 TRIM + WW-4 WALL WASH ACCESSORY - FOOTCANDLES ON WALL

DISTANCE TO WALL		2.0 ft						2.5 ft						
ON CENTER SPACING			2.0 ft			2.5 ft		2.5 ft			3.0 ft			
	DISTANCE FROM CEILING	0.5 ft	0.3	0.2	0.3	0.3	0.1	0.3	0.1	0.1	0.1	0.1	0.1	
		1.5 ft	28.1	31.3	28.1	25.4	25.8	25.4	12.9	13.9	12.9	12.1	11.4	12.1
		2.5 ft	32.1	36.9	32.1	28.6	33.0	28.6	21.6	24.5	21.6	19.7	21.8	19.7
		3.5 ft	21.9	24.6	21.9	19.7	23.2	19.7	18.8	21.6	18.8	17.0	20.0	17.0
		4.5 ft	13.6	14.8	13.6	12.5	14.3	12.5	13.4	15.0	13.4	12.3	14.3	12.3
		5.5 ft	8.6	9.1	8.6	8.0	8.9	8.0	9.1	10.0	9.1	8.5	9.6	8.5
		6.5 ft	5.6	5.9	5.6	5.3	5.8	5.3	6.3	6.7	6.3	5.9	6.6	5.9
		7.5 ft	3.8	4.0	3.8	3.7	3.9	3.7	4.4	4.7	4.4	4.2	4.6	4.2
		8.5 ft	2.7	2.8	2.7	2.6	2.8	2.6	3.2	3.3	3.2	3.1	3.3	3.1
		9.5 ft	2.0	2.0	2.0	1.9	2.0	1.9	2.4	2.4	2.4	2.3	2.4	2.3

Note: With HI LED option, use 40° optic and 20° aiming angle for optimal performance. Data shown for 3000K CCT.

400-HI-2-10-FL w/ FLR-4 TRIM + WW-4 WALL WASH ACCESSORY - FOOTCANDLES ON WALL

DISTANCE TO WALL		2.0 ft						2.5 ft						
ON CENTER SPACING			2.0 ft			2.5 ft		2.5 ft			3.0 ft			
	DISTANCE FROM CEILING	0.5 ft	0.5	0.4	0.5	0.5	0.3	0.5	0.2	0.2	0.2	0.2	0.2	
		1.5 ft	19.5	21.2	19.5	17.6	16.9	17.6	8.4	8.7	8.4	7.8	7.1	7.8
		2.5 ft	23.8	26.9	23.8	21.2	23.7	21.2	15.7	17.6	15.7	14.3	15.6	14.3
		3.5 ft	16.7	18.4	16.7	15.2	17.1	15.2	14.1	15.8	14.1	12.9	14.6	12.9
		4.5 ft	10.6	11.3	10.6	9.8	10.8	9.8	10.2	11.2	10.2	9.5	10.7	9.5
		5.5 ft	6.7	7.1	6.7	6.4	6.8	6.4	7.1	7.6	7.1	6.7	7.3	6.7
		6.5 ft	4.4	4.6	4.4	4.2	4.5	4.2	4.9	5.2	4.9	4.7	5.0	4.7
		7.5 ft	3.0	3.1	3.0	2.9	3.0	2.9	3.5	3.6	3.5	3.3	3.5	3.3
		8.5 ft	2.1	2.2	2.1	2.1	2.1	2.1	2.5	2.6	2.5	2.4	2.5	2.4
		9.5 ft	1.5	1.6	1.5	1.5	1.6	1.5	1.8	1.9	1.8	1.8	1.9	1.8

Note: With HI-2 LED option, use 10° optic + FL lens and 20° aiming angle for optimal performance. Data shown for 3000K CCT.

400-WD-40 w/ FLR-4 TRIM + WW-4 WALL WASH ACCESSORY - FOOTCANDLES ON WALL

DISTANCE TO WALL		2.0 ft						2.5 ft						
ON CENTER SPACING			2.0 ft			2.5 ft		2.5 ft			3.0 ft			
	DISTANCE FROM CEILING	0.5 ft	0.3	0.2	0.3	0.3	0.2	0.3	0.1	0.1	0.1	0.1	0.1	
		1.5 ft	20.7	23.1	20.7	18.6	18.3	18.6	9.1	10.0	9.1	8.4	8.9	8.4
		2.5 ft	26.5	30.3	26.5	23.5	26.4	23.5	17.0	19.2	17.0	15.4	16.6	15.4
		3.5 ft	19.0	21.2	19.0	17.0	19.6	17.0	15.8	18.0	15.8	14.3	16.4	14.3
		4.5 ft	12.0	12.9	12.0	11.1	12.3	11.1	11.6	12.9	11.6	10.7	12.2	10.7
		5.5 ft	7.6	8.0	7.6	7.2	7.7	7.2	8.0	8.7	8.0	7.5	8.3	7.5
		6.5 ft	5.0	5.2	5.0	4.8	5.1	4.8	5.6	5.9	5.6	5.3	5.7	5.3
		7.5 ft	3.4	3.5	3.4	3.3	3.4	3.3	3.9	4.1	3.9	3.8	4.0	3.8
		8.5 ft	2.4	2.5	2.4	2.3	2.4	2.3	2.8	2.9	2.8	2.7	2.9	2.7
		9.5 ft	1.7	1.8	1.7	1.7	1.8	1.7	2.1	2.2	2.1	2.0	2.1	2.0

Note: With WD, WD-2, or WD-4 LED option, use 40° optic and 20° aiming angle for optimal performance. Data shown for 3000K CCT.