

HOUSING: **805** – SUPER SHALLOW  
 LAMP MODULE: **W5** – WALL WASH | LED  
 TRIM: **FS/FR + FLS/FLR** w/ **WW-8** WALL WASH ACCESSORY



526 Portal Street  
 Cotati, CA 94931  
 USA  
 P 707.794.0888  
 www.8lighting.com

All No. 8 Lighting fixtures and components are UL Listed to both U.S. and Canadian requirements. Select 8045 Series fixtures and components are also CE Certified. No. 8 Lighting trims and lamp modules are protected by one or more U.S. Patents. No. 8 Lighting reserves the right to change details of design, materials, and finish.  
 © 2023 No. 8 Lighting  
 Doc # 91176-13.0



Project Name	
Date	Type
Prepared By	
Comments	
Catalog # <b>805/W5</b> –        –        –        /        –        /	
–        –        – <b>WW-8</b>	

PRODUCT FEATURES

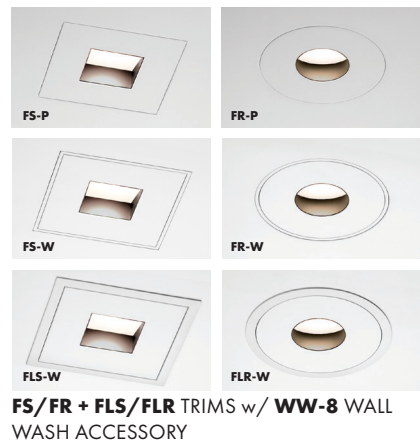
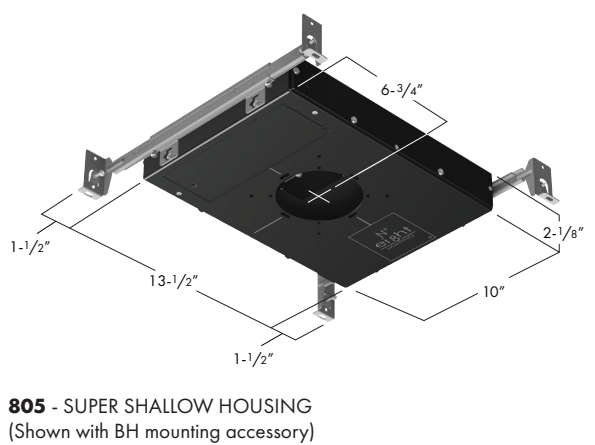



**805/W5** w/ **WW-8** WALL WASH ACCESSORY - SPECIFICATION SUMMARY

	Static White Standard Output				Static White High Output		Warm Dimming	
	HI-2-27	HI-2	HI-27	HI	HI-27	HI	WD	WD-2
LED Option	479-522	524-572	635-674	688-723	825-877	891-943	551-585	568-608
Delivered Lumens	15.0	15.0	14.5	14.5	20.5	20.5	15.0	15.0
System Wattage	32-35	35-38	45-46	47-50	40-43	43-46	37-39	38-41
Efficacy	95	95	95	94	94	94	97	97
R9	64	65	63	63	61	60	82	79
CCT	2700K	3000K	2700K	3000K	2700K	3000K	3000-1800K	2800-2200K
Optic Options	10-FL		40				40	
Color Consistency	2-Step						3-Step	
Optical Accessories	2400K, 2700K, 3500K Color Filters							
Adjustability	20° Tilt (Fixed) and 0°, 90°, 180°, or 270° Rotation (Field Adjustable)							
Dimming Options	<1% Forward/Reverse Phase (120v), 0.1/1% 0-10v (120-277v), 0.1/1% DALI (120-277v), 0.1% EcoSystem (120 or 277v)							
Trim Options	1-3/4" Aperture Round/Square Wall-Wash							
Finish Options	White, Oil-Rubbed Bronze, Polished Nickel, Satin Nickel, Black							
Trim Mounting Options	Flanged, Flangeless Sheetrock, Flangeless Wood							
Trim Lens Options	UL Wet Listed and IP54 Rated - Wall-Wash							
Housing Options	New Construction: Type IC-CP Rated CCEA Approved Air-Tight							

Data shown for W5 Lamp Module with FS/FLS and FR/FLR trims and WW-8 Accessory.  
 Warm Dimming data shown for 3000K and 2800K.

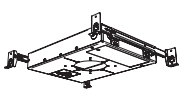

PRODUCT SPECIFIER/PRODUCT ORDER NUMBER

**805** / **W5** - - - - - / - - - - - /

HOUSING	LAMP MODULE	LED OPTIONS	OPTIC OPTIONS	OPTICAL ACCESSORIES (Optional)	DIMMING OPTIONS	OUTPUT	MOUNTING ACCESSORIES
 <p><b>805</b> New Construction – Super Shallow AIRTIGHT-IC Rated 10"W* x 13-1/2"L* x 2-1/8"H† *Add 3" to length or width to accommodate mounting accessories. †Minimum 2-5/8" ceiling space required when used with INSET and BEVEL Series trim assemblies.</p>	 <p><b>W5</b> LED WALL WASH 20° tilt, 90° rotation</p>	<p><b>HI-27</b> 2700K White LED <b>HI</b> 3000K White LED <b>HI-2-27*</b> 2700K White LED <b>HI-2*</b> 3000K White LED <b>WD†</b> 3000-1800K Warm Dim LED <b>WD-2†</b> 2800-2200K Warm Dim LED *For use with 10° optic only. Available in standard output only. †Available in standard output only.</p>	<p><b>40</b> 40° Flood <b>10-FL*</b> 10° Very Narrow Spot + FL Beam Enhancing Lens *For use with HI-2 LED option only.</p>	<p><b>CF24*</b> 2400K Color Filtering Lens <b>CF27*</b> 2700K Color Filtering Lens <b>CF35*</b> 3500K Color Filtering Lens *For use with HI and HI-2 3000K LED options only.</p>	<p><b>PR1-8.5</b> Premium Forward or Reverse-Phase &lt;1% Dimming <b>EL1-8.5*</b> EldoLED 0-10V 1% Dimming <b>EL1-01-8.5*</b> EldoLED 0-10v 0.1% Dimming <b>EL2-8.5*</b> EldoLED DALI 1% Dimming <b>EL2-01-8.5*</b> EldoLED DALI 0.1% Dimming <b>LU4-8.5*</b> Lutron Hi-Lume PEQOE 0.1% EcoSystem Dimming *Available in standard output only.</p>	<p><b>1000</b> Standard output <b>1000-WD</b> Standard output – Warm Dimming <b>1400*</b> High output *Not available w/ EL1, EL1-01, EL2, EL2-01 or LU4 dimming options.</p>	<p><b>BH</b> Bar Hangers for joist mounting <b>BB</b> Butterfly Brackets for c-channel or bar mounting <b>TBC-BH</b> T-Bar Mounting Clips + Bar Hangers for T-Bar mounting <b>PMB</b> Panel Mounting Brackets (set of two) for direct mounting to wood panels</p>

TRIM PRODUCT SPECIFIER/PRODUCT ORDER NUMBER

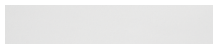
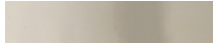
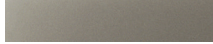
- - - - - **WW-8**

TRIM	TRIM APPLICATION	TRIM FINISH	TRIM ACCESSORY
<p><b>FS</b> FLANGELESS SQUARE – Trim plate flush to the ceiling <b>FR</b> FLANGELESS ROUND – Trim plate flush to the ceiling <b>FLS</b> FLANGED SQUARE – Trim plate flush to trim <b>FLR</b> FLANGED ROUND – Trim plate flush to trim</p>	<p><b>P-1</b> Flush Plaster/Sheetrock ceiling applications with 5/32" thick drywall compound or plaster finish <b>P-2</b> Flush Plaster/Sheetrock ceiling applications with 5/16" thick drywall compound or plaster finish <b>W</b> Wood/Stone/Sheetrock/Acoustic Tile ceiling applications</p>	 <p><b>WH</b> WHITE</p>  <p><b>PN</b> POLISHED NICKEL*</p>  <p><b>SN</b> SATIN NICKEL*</p>  <p><b>OB</b> OIL-RUBBED BRONZE*</p>  <p><b>BK</b> BLACK* *Specialty finish.</p>	<p><b>WW-8*</b> WALL WASH accessory installed in 1.75" aperture trim plate *UL WET LISTED and IP54 Rated for use in DRY, DAMP, or WET locations (covered ceiling applications only). Approved for use in residential steam applications. Not for use in commercial steam applications.</p>

**Housing and Installation Notes**

**805** Super shallow universal IC Rated housing available with two output options. Meets Washington State Airtight Standard WAC 51-11-0502 and in accordance with ASTM E283 to reduce energy loss. CCEA plenum rated for City of Chicago environmental air spaces. Standard and high output options are IC Rated for direct contact with standard or spray-foam thermal insulation with a max combined R-Value of R42. For standard output models, ambient temperatures in ceiling space should not exceed 40°C (104°F) during normal operation. For high output models, ambient temperatures should not exceed 25°C (77°F).

**Lamp Module, LED, and Accessory Notes**

**W5** Wall wash lamp module and **WW-8** wall wash accessory installed with **FS/FR** or **FLS/FLR 800 Series** trims for uniform wall wash applications. To ensure fixture to fixture color consistency, use of the same LED option with adjacent fixtures is recommended.

**Dimming and Output Option Notes**

0-10v dimming options are configured for linear control. DALI dimming options are configured for logarithmic control. No.8 Lighting conducts extensive testing to establish compatibility with many dimmer types. For a complete list of compatible dimmers, see [8lighting.com/resources-downloads](http://8lighting.com/resources-downloads). Outputs vary depending on LED type, trim type, and optical accessories used. For photometric files in PDF and IES formats, see [8lighting.com/800-series-photometry](http://8lighting.com/800-series-photometry).

**Warranty**

All No. 8 Lighting products are covered by a 5 year limited warranty. Products installed in residential steam applications are covered by a 2 year limited warranty. For specific warranty details and limitations, see [8lighting.com/resources-downloads](http://8lighting.com/resources-downloads).

**805/W5 w/ FS/FLS-WW-8 1.75" APERTURE TRIM - PERFORMANCE SUMMARY**

LED	OUTPUT	OPTIC OPTION	CCT	CRI	R9	Delivered Lumens	System Wattage	Delivered LPW
HI-27	1000	40	2700K	95	63	674	14.5	46
HI	1000	40	3000K	95	63	723	14.5	50
HI-27	1400	40	2700K	94	61	877	20.5	43
HI	1400	40	3000K	94	60	943	20.5	46
HI-2-27	1000	10-FL	2700K	95	64	522	15.0	35
HI-2	1000	10-FL	3000K	95	66	572	15.0	38
WD	1000-WD	40	3000-1800K	97	82	585	15.0	39
WD-2	1000-WD	40	2800-2200K	97	80	608	15.0	41

Performance summary for **WD** LED at 3000K, **WD-2** LED at 2800K.

**805/W5-HI-40/1000 w/ FS/FLS TRIM + WW-8 WALL WASH ACCESSORY – FOOTCANDLES ON WALL**

DISTANCE TO WALL		2.0 ft						2.5 ft						
			2.0 ft			2.5 ft			2.5 ft			3.0 ft		
	DISTANCE FROM CEILING	0.5 ft	0.8	0.5	0.8	0.7	0.3	0.7	0.1	0.1	0.1	0.1	0.1	0.1
		1.5 ft	28.7	29.6	28.7	26.3	23.2	26.3	14.3	14.1	14.3	13.4	11.2	13.4
		2.5 ft	29.5	32.3	29.5	26.6	27.7	26.6	20.5	22.0	20.5	18.9	18.9	18.9
		3.5 ft	19.8	21.7	19.8	18.0	19.7	18.0	17.1	18.8	17.1	15.7	17.0	15.7
		4.5 ft	12.3	13.2	12.3	11.4	12.4	11.4	12.1	13.2	12.1	11.2	12.3	11.2
		5.5 ft	7.7	8.1	7.7	7.3	7.8	7.3	8.3	8.9	8.3	7.8	8.4	7.8
		6.5 ft	5.0	5.2	5.0	4.8	5.1	4.8	5.7	6.0	5.7	5.4	5.8	5.4
		7.5 ft	3.4	3.5	3.4	3.3	3.4	3.3	4.0	4.1	4.0	3.8	4.0	3.8
		8.5 ft	2.4	2.5	2.4	2.3	2.4	2.3	2.9	3.0	2.9	2.8	2.9	2.8
		9.5 ft	1.7	1.8	1.7	1.7	1.7	1.7	2.1	2.2	2.1	2.0	2.1	2.0

Note: With **HI** LED option, use 40° optic and 20° aiming angle for optimal performance. Data shown for 3000K CCT.

**805/W5-HI-40/1400 w/ FS/FLS TRIM + WW-8 WALL WASH ACCESSORY – FOOTCANDLES ON WALL**

DISTANCE TO WALL		2.0 ft						2.5 ft						
			2.0 ft			2.5 ft			2.5 ft			3.0 ft		
	DISTANCE FROM CEILING	0.5 ft	1.0	0.9	1.0	1.0	0.6	1.0	0.2	0.2	0.2	0.2	0.2	0.2
		1.5 ft	38.2	41.9	38.2	34.9	32.9	34.9	19.1	20.5	19.1	17.8	16.3	17.8
		2.5 ft	39.1	44.5	39.1	35.2	38.3	35.2	27.2	30.6	27.2	25.0	26.3	25.0
		3.5 ft	26.3	29.3	26.3	23.8	26.8	23.8	22.7	25.8	22.7	20.8	23.3	20.8
		4.5 ft	16.2	17.6	16.2	15.0	16.6	15.0	16.0	17.9	16.0	14.8	16.7	14.8
		5.5 ft	10.2	10.8	10.2	9.6	10.4	9.6	10.9	11.9	10.9	10.2	11.3	10.2
		6.5 ft	6.6	6.9	6.6	6.3	6.7	6.3	7.5	8.0	7.5	7.1	7.7	7.1
		7.5 ft	4.5	4.7	4.5	4.3	4.5	4.3	5.2	5.5	5.2	5.0	5.4	5.0
		8.5 ft	3.2	3.3	3.2	3.1	3.2	3.1	3.7	3.9	3.7	3.6	3.8	3.6
		9.5 ft	2.3	2.4	2.3	2.2	2.3	2.2	2.8	2.9	2.8	2.7	2.8	2.7

Note: With **HI** LED option, use 40° optic and 20° aiming angle for optimal performance. Data shown for 3000K CCT.

**805/W5-HI-2-10-FL/1000 w/ FS/FLS TRIM + WW-8 WALL WASH ACCESSORY – FOOTCANDLES ON WALL**

DISTANCE TO WALL		2.0 ft						2.5 ft						
ON CENTER SPACING			2.0 ft			2.5 ft			2.5 ft			3.0 ft		
	DISTANCE FROM CEILING	0.5 ft	1.0	1.2	1.0	0.9	0.9	0.9	0.3	0.3	0.3	0.3	0.2	0.3
		1.5 ft	22.6	25.4	22.6	20.4	21.1	20.4	10.8	12.0	10.8	10.0	10.2	10.0
		2.5 ft	23.6	26.5	23.6	21.2	23.9	21.2	16.5	18.6	16.5	15.1	16.7	15.1
		3.5 ft	15.8	17.3	15.8	14.5	16.2	14.5	13.7	15.2	13.7	12.6	14.2	12.6
		4.5 ft	9.8	10.5	9.8	9.2	10.1	9.2	9.7	10.5	9.7	9.0	10.1	9.0
		5.5 ft	6.2	6.5	6.2	5.9	6.3	5.9	6.6	7.0	6.6	6.3	6.8	6.3
		6.5 ft	4.1	4.2	4.1	3.9	4.1	3.9	4.5	4.8	4.5	4.4	4.7	4.4
		7.5 ft	2.8	2.8	2.8	2.7	2.8	2.7	3.2	3.3	3.2	3.1	3.3	3.1
		8.5 ft	1.9	2.0	1.9	1.9	2.0	1.9	2.3	2.4	2.3	2.2	2.3	2.2
		9.5 ft	1.4	1.4	1.4	1.4	1.4	1.4	1.7	1.7	1.7	1.7	1.7	1.7

Note: With HI-2 LED option, use 10° optic + FL lens and 20° aiming angle for optimal performance. Data shown for 3000K CCT.

**805/W5-WD-40/1000-WD w/ FS/FLS TRIM + WW-8 WALL WASH ACCESSORY – FOOTCANDLES ON WALL**

DISTANCE TO WALL		2.0 ft						2.5 ft						
ON CENTER SPACING			2.0 ft			2.5 ft			2.5 ft			3.0 ft		
	DISTANCE FROM CEILING	0.5 ft	0.6	0.7	0.6	0.6	0.4	0.6	0.1	0.1	0.1	0.1	0.1	
		1.5 ft	20.8	23.2	20.8	19.0	18.2	19.0	10.0	11.0	10.0	9.3	8.8	9.3
		2.5 ft	23.4	27.2	23.4	21.0	23.2	21.0	15.6	17.9	15.6	14.3	15.3	14.3
		3.5 ft	16.8	19.1	16.8	15.1	17.3	15.1	13.9	16.1	13.9	12.7	14.5	12.7
		4.5 ft	10.7	11.8	10.7	9.9	11.1	9.9	10.3	11.7	10.3	9.5	10.8	9.5
		5.5 ft	6.8	7.3	6.8	6.4	7.0	6.4	7.2	7.9	7.2	6.7	7.5	6.7
		6.5 ft	4.5	4.7	4.5	4.3	4.6	4.3	5.0	5.4	5.0	4.7	5.2	4.7
		7.5 ft	3.0	3.2	3.0	2.9	3.1	2.9	3.5	3.7	3.5	3.4	3.6	3.4
		8.5 ft	2.1	2.2	2.1	2.1	2.2	2.1	2.5	2.7	2.5	2.5	2.6	2.5
		9.5 ft	1.6	1.6	1.6	1.5	1.6	1.5	1.9	2.0	1.9	1.8	1.9	1.8

Note: With WD or WD-2 LED option, use 40° optic and 20° aiming angle for optimal performance. Data shown for 3000K CCT.

**805/W5 w/ FR/FLR-WW-8 1.75" APERTURE TRIM - PERFORMANCE SUMMARY**

LED	OUTPUT	OPTIC OPTION	CCT	CRI	R9	Delivered Lumens	System Wattage	Delivered LPW
HI-27	1000	40	2700K	95	63	635	14.5	44
HI	1000	40	3000K	94	62	688	14.5	47
HI-27	1400	40	2700K	94	61	825	20.5	40
HI	1400	40	3000K	94	60	891	20.5	43
HI-2-27	1000	10-FL	2700K	95	64	479	15.0	32
HI-2	1000	10-FL	3000K	95	65	524	15.0	35
WD	1000-WD	40	3000-1800K	97	82	551	15.0	37
WD-2	1000-WD	40	2800-2200K	97	79	568	15.0	38

Performance summary for **WD** LED at 3000K, **WD-2** LED at 2800K.

**805/W5-HI-40/1000 w/ FR/FLR TRIM + WW-8 WALL WASH ACCESSORY – FOOTCANDLES ON WALL**

DISTANCE TO WALL		2.0 ft						2.5 ft						
		ON CENTER SPACING			2.0 ft			2.5 ft		2.5 ft			3.0 ft	
	DISTANCE FROM CEILING	0.5 ft	0.7	0.6	0.7	0.6	0.4	0.6	0.1	0.1	0.1	0.1	0.1	0.1
		1.5 ft	27.5	31.2	27.5	24.9	24.7	24.9	13.5	15.1	13.5	12.6	12.0	12.6
		2.5 ft	29.1	33.6	29.1	26.1	28.9	26.1	19.9	22.8	19.9	18.2	19.7	18.2
		3.5 ft	20.1	22.7	20.1	18.1	20.8	18.1	17.0	19.6	17.0	15.6	17.7	15.6
		4.5 ft	12.6	13.8	12.6	11.6	13.1	11.6	12.3	13.9	12.3	11.3	13.0	11.3
		5.5 ft	7.9	8.5	7.9	7.4	8.2	7.4	8.4	9.3	8.4	7.9	8.9	7.9
		6.5 ft	5.2	5.5	5.2	4.9	5.3	4.9	5.8	6.3	5.8	5.5	6.1	5.5
		7.5 ft	3.5	3.7	3.5	3.4	3.6	3.4	4.1	4.3	4.1	3.9	4.2	3.9
		8.5 ft	2.5	2.6	2.5	2.4	2.5	2.4	2.9	3.1	2.9	2.8	3.0	2.8
9.5 ft	1.8	1.8	1.8	1.7	1.8	1.7	2.2	2.3	2.2	2.1	2.2	2.1		

Note: With **HI** LED option, use 40° optic and 20° aiming angle for optimal performance. Data shown for 3000K CCT.

**805/W5-HI-40/1400 w/ FR/FLR TRIM + WW-8 WALL WASH ACCESSORY – FOOTCANDLES ON WALL**

DISTANCE TO WALL		2.0 ft						2.5 ft						
		ON CENTER SPACING			2.0 ft			2.5 ft		2.5 ft			3.0 ft	
	DISTANCE FROM CEILING	0.5 ft	0.9	0.7	0.9	0.9	0.5	0.9	0.2	0.2	0.2	0.2	0.1	0.2
		1.5 ft	35.8	40.5	35.8	32.4	32.0	32.4	17.6	19.6	17.6	16.3	15.7	16.3
		2.5 ft	37.8	43.6	37.8	34.0	37.6	34.0	25.9	29.7	25.9	23.7	25.6	23.7
		3.5 ft	26.1	29.6	26.1	23.6	27.0	23.6	22.2	25.5	22.2	20.3	23.0	20.3
		4.5 ft	16.4	18.0	16.4	15.1	17.0	15.1	16.0	18.0	16.0	14.8	16.9	14.8
		5.5 ft	10.3	11.1	10.3	9.7	10.6	9.7	11.0	12.1	11.0	10.3	11.5	10.3
		6.5 ft	6.7	7.1	6.7	6.4	6.9	6.9	7.6	8.2	7.6	7.2	7.9	7.2
		7.5 ft	4.6	4.8	4.6	4.4	4.7	4.4	5.3	5.6	5.3	5.1	5.5	5.1
		8.5 ft	3.2	3.3	3.2	3.1	3.3	3.1	3.8	4.0	3.8	3.7	3.9	3.7
9.5 ft	2.3	2.4	2.3	2.3	2.4	2.3	2.8	2.9	2.8	2.7	2.9	2.7		

Note: With **HI** LED option, use 40° optic and 20° aiming angle for optimal performance. Data shown for 3000K CCT.

**805/W5-HI-2-10-FL/1000 w/ FR/FLR TRIM + WW-8 WALL WASH ACCESSORY – FOOTCANDLES ON WALL**

DISTANCE TO WALL		2.0 ft						2.5 ft						
ON CENTER SPACING			2.0 ft			2.5 ft		2.5 ft			3.0 ft			
	DISTANCE FROM CEILING	0.5 ft	1.1	0.8	1.1	1.0	0.7	1.0	0.3	0.3	0.3	0.3	0.2	0.3
		1.5 ft	20.0	21.7	20.0	18.2	17.6	18.2	9.5	9.9	9.5	8.8	8.3	8.8
		2.5 ft	21.5	23.9	21.5	19.3	21.4	19.3	14.8	16.5	14.8	13.5	14.7	13.5
		3.5 ft	14.8	16.1	14.8	13.5	15.0	13.5	12.6	13.9	12.6	11.6	12.9	11.6
		4.5 ft	9.3	10.0	9.3	8.7	9.5	8.7	9.0	9.9	9.0	8.4	9.3	8.4
		5.5 ft	6.0	6.3	6.0	5.6	6.1	5.6	6.3	6.7	6.3	5.9	6.5	5.9
		6.5 ft	3.9	4.1	3.9	3.8	4.0	3.8	4.3	4.6	4.3	4.2	4.5	4.2
		7.5 ft	2.7	2.8	2.7	2.6	2.7	2.6	3.1	3.2	3.1	3.0	3.2	3.0
		8.5 ft	1.9	1.9	1.9	1.9	1.9	1.9	2.2	2.3	2.2	2.2	2.3	2.2
		9.5 ft	1.4	1.4	1.4	1.4	1.4	1.4	1.7	1.7	1.7	1.7	1.7	1.6

Note: With HI-2 LED option, use 10° optic + FL lens and 20° aiming angle for optimal performance. Data shown for 3000K CCT.

**805/W5-WD-40/1000-WD w/ FR/FLR TRIM + WW-8 WALL WASH ACCESSORY – FOOTCANDLES ON WALL**

DISTANCE TO WALL		2.0 ft						2.5 ft						
ON CENTER SPACING			2.0 ft			2.5 ft		2.5 ft			3.0 ft			
	DISTANCE FROM CEILING	0.5 ft	0.7	0.6	0.7	0.7	0.3	0.7	0.2	0.1	0.2	0.2	0.1	0.2
		1.5 ft	19.7	22.7	19.7	17.9	17.8	17.9	9.5	10.8	9.5	8.8	8.6	8.8
		2.5 ft	22.7	26.6	22.7	20.3	22.6	20.3	14.9	17.5	14.9	13.6	14.9	13.6
		3.5 ft	16.6	19.2	16.6	14.9	17.2	14.9	13.6	15.9	13.6	12.4	14.2	12.4
		4.5 ft	10.8	12.1	10.8	9.9	11.2	9.9	10.2	11.8	10.2	9.4	10.8	9.4
		5.5 ft	6.9	7.5	6.9	6.4	7.2	6.4	7.2	8.1	7.2	6.7	7.6	6.7
		6.5 ft	4.5	4.9	4.5	4.3	4.7	4.3	5.0	5.5	5.0	4.8	5.3	4.8
		7.5 ft	3.1	3.3	3.1	3.0	3.2	3.0	3.6	3.9	3.6	3.4	3.7	3.4
		8.5 ft	2.2	2.3	2.2	2.1	2.2	2.1	2.6	2.7	2.6	2.5	2.7	2.5
		9.5 ft	1.6	1.6	1.6	1.5	1.6	1.5	1.9	2.0	1.9	1.8	2.0	1.8

Note: With WD or WD-2 LED option, use 40° optic and 20° aiming angle for optimal performance. Data shown for 3000K CCT.