

HOUSING: **804S-4Q** - LOW PROFILE MULTI-LAMP LAMP MODULE: **J2S** or **K2S** | LED

Project Name	
Date	Type
Prepared By	
Comments	
Catalog # 804S-4Q / - / / L1 - - -	
/ L2 - - - / L3 - - - / L4 - - -	



526 Portal Street
Colton, CA 94931
USA
P 707.794.0888
www.8lighting.com

All No. 8 Lighting fixtures and components are UL Listed to both U.S. and Canadian requirements. No. 8 Lighting trims and lamp modules are protected by one or more U.S. Patents. No. 8 Lighting reserves the right to change details of design, materials, and finish.

© 2023 No. 8 Lighting
Doc # 91163-13.1



PRODUCT FEATURES

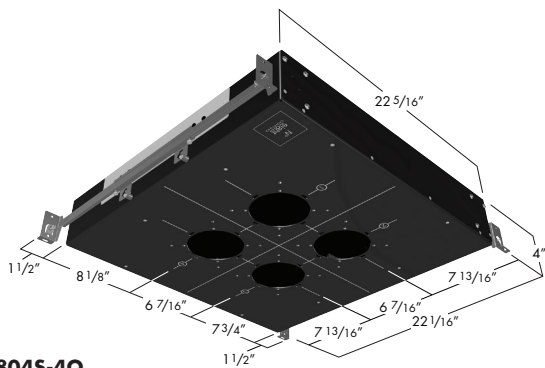

804S-4Q
LOW PROFILE MULTI-LAMP HOUSING
(shown with BH mounting accessory)



J2S - LED ADJUSTABLE



K2S - LED FIXED POSITION



804S-4Q with **FS-P** trim
(Specified separately)

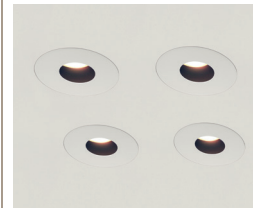

804S-4Q with **FR-P** trim
(Specified separately)

804S-4Q SPECIFICATION SUMMARY

LED Option	Static White Standard Output				Warm Dimming	
	HI-2-27	HI-2	HI-27	HI	WD	WD-2
Delivered Lumens	4200	4516	4166	4524	3692	3660
System Wattage	58	158	56	56	58	58
Efficacy	72	78	74	80	64	63
CRI	94	94	94	94	97	96
R9	62	63	59	60	81	78
CCT	2700K	3000K	2700K	3000K	3000-1800K	2800-2200K
Optic Options	10		15, 25, 40		15, 25, 40	
Color Consistency	2-Step				3-Step	
Optical Accessories	Narrow, Medium, Wide, Extra Wide, Linear Spread, and 2400K, 2700K, 3500K Color Filters					
Adjustability	J2S - 0-45° Tilt, 360° Rotation, Lockable / K2S - Fixed Position					
Dimming Options	<1% Forward/Reverse Phase (120v), 0.1/1% 0-10v (120-277v), 0.1/1% DALI (120-277v), 0.1/1% EcoSystem (120 or 277v)					
Trim Options	Round/Square Flat, Round/Square Bevel, Round/Square Inset, Round/Square Wall-Wash					
Finish Options	White, Oil-Rubbed Bronze, Polished Nickel, Satin Nickel, Black					
Trim Mounting Options	Flanged, Flangeless Sheetrock, Flangeless Wood					
Trim Lens Options	UL Wet Listed and IP54 Rated - Clear, Soft Focus, Wall-Wash					
Housing Options	New Construction: Type IC-CP Rated CCEA Approved Air-Tight					

Data shown for Qty. 4 K2S Lamp Modules with FS/FLS/INS-LG/NL trims.
Warm Dimming data shown for 3000K and 2800K.
See Performance Summaries for additional information.
800 Series Trims specified separately.

PRODUCT SPECIFIER/PRODUCT ORDER NUMBER

804S-4Q

HOUSING

DIMMING OPTIONS

OUTPUT

MOUNTING ACCESSORIES

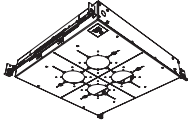

804S-4Q

New Construction -
Low Profile AIRTIGHT-IC
22 1/16"W x 22 5/16"L* x 4"H†

*Add 3" to length to accommodate mounting accessories.

†Minimum 4-1/2" ceiling space required when used with INSET and BEVEL Series trim assemblies.

PR1-8

Premium Forward or Reverse-Phase
<1% Dimming

EL1-8†

EldoLED 0-10v 1% Dimming

EL1-01-8†

EldoLED 0-10v 0.1% Dimming

EL2-8†

EldoLED DALI 1% Dimming

EL2-01-8†

EldoLED DALI 0.1% Dimming

LU2-8

Lutron Hi-Lume LDE1 Eco-System 1% Dimming

LU4-8

Lutron Hi-Lume PEQOE EcoSystem 0.1% Dimming

†Also CE Certified with HI or HI-2 LED options.

1000

Standard output

1000-WD

Standard output - Warm Dimming

BH

Bar Hangers for joist mounting

BB

Butterfly Brackets for c-channel or bar mounting

TBC-BH

T-Bar Mounting Clips + Bar Hangers for T-Bar mounting

PMB

Panel Mounting Brackets (set of two) for direct mounting to wood panels

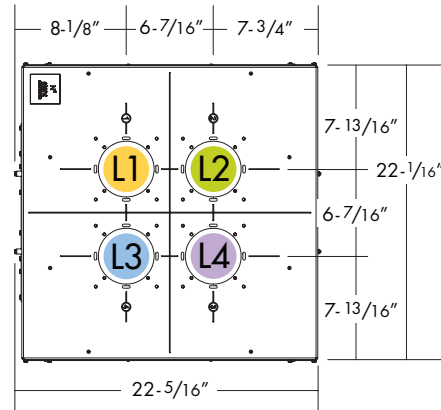

A combination Lamp Module, LED, Optic Option, and (optional) Optical Accessory is required for each lamp position. Lamp Modules can be intermixed within the same housing and are independently controllable.

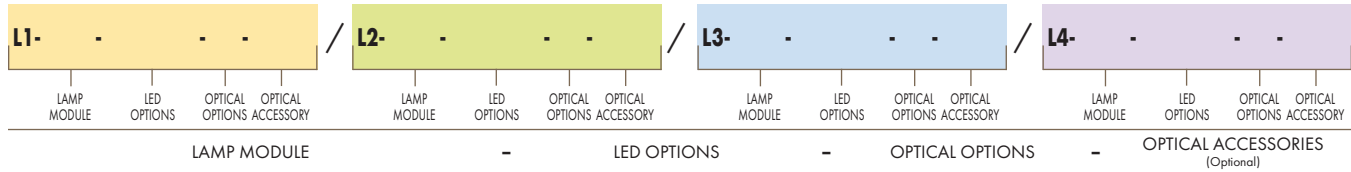

J25
LED ADJUSTABLE
45° tilt, full 360° rotation with tool-less locking



K25
LED FIXED POSITION

HI-27

2700K White LED

HI

3000K White LED

HI-2-27*

2700K White LED

HI-2*

3000K White LED

WD

3000 - 1800K Warm Dim LED

WD-2

2800 - 2200K Warm Dim LED

* For use with 10° optic only.

10*

10° Very Narrow Spot

15

15° Narrow Spot

25

25° Narrow Flood

40

40° Flood

*For use with HI-2 LED only.

NSP

Narrow Softening Lens

NFL

Medium Softening Lens

FL

Wide Softening Lens

WFL

Extra Wide Softening Lens

LS

Linear Spread Lens

CF24*

2400K Color Filtering Lens

CF27*

2700K Color Filtering Lens

CF35*

3500K Color Filtering Lens

*For use with HI and HI-2 3000K LED options only.

Housing and Installation Notes

804S-4Q Low Profile AIRTIGHT IC-Rated for direct contact with standard or spray-foam thermal insulation with a max combined R-Value of R42 (may also be installed in Non-IC applications). Meets Washington State Airtight Standard WAC 51-11-0502 and in accordance with ASTM E283 to reduce energy loss. CCEA plenum rated for City of Chicago environmental air spaces. Ambient temperatures in ceiling space should not exceed 40°C (104°F) during normal operation. For models with **EL1-8**, **EL1-01-8**, **EL2-8**, **EL2-01-8**, or **LU2-8** dimming options, ambient temperatures should not exceed 25°C (77°F). Accepts four **J25** or **K25** LED Lamp Modules and four **800 Series** Trim Assemblies. For **800 Series** Trims (specified separately), see 8lighting.com/products-800-series-led.

Dimming and Output Option Notes

0-10v dimming options are configured for linear control. DALI dimming options are configured for logarithmic control. No.8 Lighting conducts extensive testing to establish compatibility with many dimmer types. For a complete list of compatible dimmers, see 8lighting.com/resources-downloads. Outputs vary depending on LED type, trim type, and optical accessories used. For photometric files in PDF and IES formats, see 8lighting.com/800-series-photometry.

Lamp Module, LED, Optic Option, and Accessory Notes

J25 Fully adjustable lamp module features patented tool-free adjustment mechanism. Use for adjustable accent, wall wash*, and general lighting applications. *For wall washing: specify 40° optic option with **HI**, **WD**, or **WD-2** LED or 10° optic option and **FL** lens with **HI-2** LED. Requires **WW-8** wall wash accessory, specified with **FS/FR** or **FLS/FLR** (1.75" aperture) **800 Series** trims.

K25 Fixed position lamp module for general lighting applications. To ensure fixture to fixture color consistency, use of the same LED option with adjacent fixtures is recommended. One field interchangeable optic option included standard. Up to two additional optical accessories can be accommodated.

Warranty

All No. 8 Lighting products are covered by a 5 year limited warranty. Products installed in residential steam applications are covered by a 2 year limited warranty. For specific warranty details and limitations, see 8lighting.com/resources-downloads.

JA8-2022 CA Title 24 Compliant.

804S-4Q/J2S w/ FS/FLS/INS 1.75" APERTURE TRIM - PERFORMANCE SUMMARY

LED	OUTPUT	CCT	CRI	R9	Delivered Lumens	System Wattage	Delivered LPW
HI-27	1000	2700K	94	59	2946-3530	56	53-63
HI	1000	3000K	94	60	3168-3796	56	57-68
HI-2-27	1000	2700K	94	62	3820	58	66
HI-2	1000	3000K	94	63	4108	58	71
WD	1000-WD	3000-1800K	97	82	2408-2940	58	42-51
WD-2	1000-WD	2800-2200K	96	78	2392-2924	58	41-50

Performance summary for HI LED with 15°, 25°, and 40° optic options and HI-2 LED with 10° optic option.

Performance summary for WD LED at 3000K and WD-2 LED at 2800K with 15°, 25°, and 40° optic options.

804S-4Q/J2S w/ FR/FLR/INR 1.75" APERTURE TRIM - PERFORMANCE SUMMARY

LED	OUTPUT	CCT	CRI	R9	Delivered Lumens	System Wattage	Delivered LPW
HI-27	1000	2700K	94	59	2857-3501	56	51-63
HI	1000	3000K	94	60	3072-3764	56	55-67
HI-2-27	1000	2700K	94	62	3783	58	65
HI-2	1000	3000K	94	63	4068	58	70
WD	1000-WD	3000-1800K	97	81	2400-2956	58	41-51
WD-2	1000-WD	2800-2200K	97	77	2380-2956	58	41-51

Performance summary for HI LED with 15°, 25°, and 40° optic options and HI-2 LED with 10° optic option.

Performance summary for WD LED at 3000K and WD-2 LED at 2800K with 15°, 25°, and 40° optic options.

804S-4Q/J2S w/ FS/FLS/INS-LG/NL 2.75" APERTURE TRIM - PERFORMANCE SUMMARY

LED	OUTPUT	CCT	CRI	R9	Delivered Lumens	System Wattage	Delivered LPW
HI-27	1000	2700K	94	59	3352-3873	56	60-69
HI	1000	3000K	94	60	3604-4164	56	64-74
HI-2-27	1000	2700K	94	62	3884	58	67
HI-2	1000	3000K	94	63	4176	58	72
WD	1000-WD	3000-1800K	97	82	2908-3348	58	50-58
WD-2	1000-WD	2800-2200K	96	77	2912-3336	58	50-58

Performance summary for HI LED with 15°, 25°, and 40° optic options and HI-2 LED with 10° optic option.

Performance summary for WD LED at 3000K and WD-2 LED at 2800K with 15°, 25°, and 40° optic options.

804S-4Q/J2S w/ FR/FLR/INR-LG/NL 2.75" APERTURE TRIM - PERFORMANCE SUMMARY

LED	OUTPUT	CCT	CRI	R9	Delivered Lumens	System Wattage	Delivered LPW
HI-27	1000	2700K	94	59	3385-3902	56	60-70
HI	1000	3000K	94	60	3640-4196	56	65-75
HI-2-27	1000	2700K	94	62	3902	58	67
HI-2	1000	3000K	94	63	4196	58	72
WD	1000-WD	3000-1800K	97	81	2980-3448	58	51-59
WD-2	1000-WD	2800-2200K	97	77	2964-3396	58	51-59

Performance summary for HI LED with 15°, 25°, and 40° optic options and HI-2 LED with 10° optic option.

Performance summary for WD LED at 3000K and WD-2 LED at 2800K with 15°, 25°, and 40° optic options.

804S/J2S w/ FS/FLS/INS 1.75" APERTURE TRIM - CONE OF LIGHT DIAGRAMS

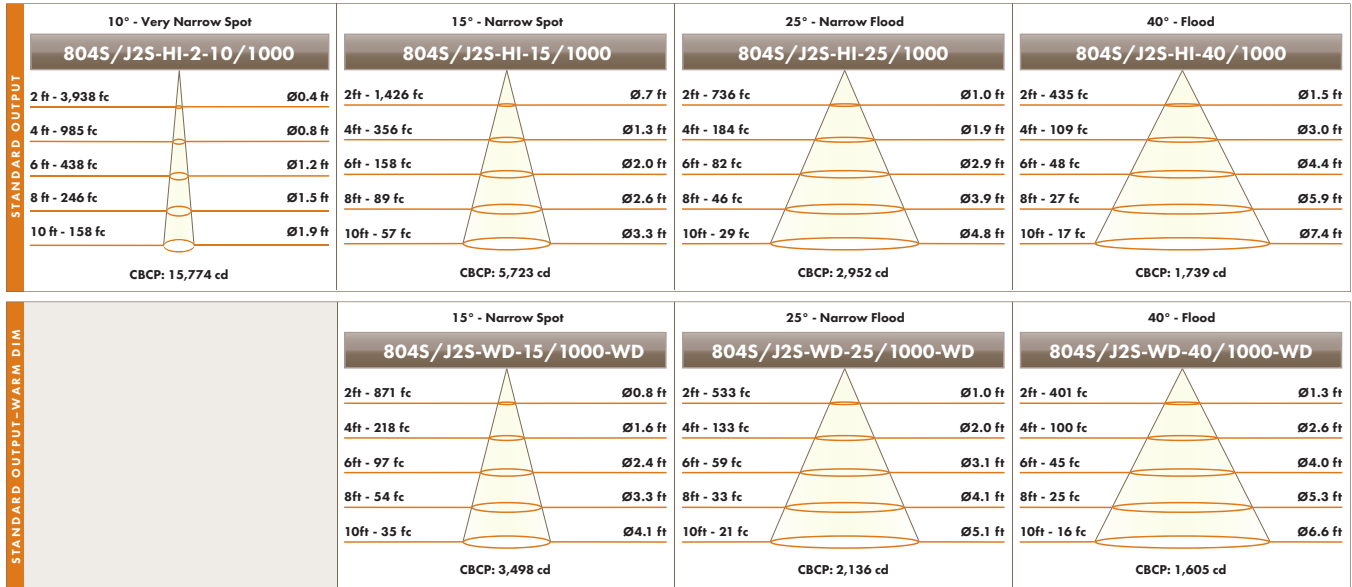

Note: Performance shown for individual lamp modules at 3000K. Output varies by CCT.

804S/J2S w/ FS/FLS/INS-LG/NL 2.75" APERTURE TRIM - CONE OF LIGHT DIAGRAMS

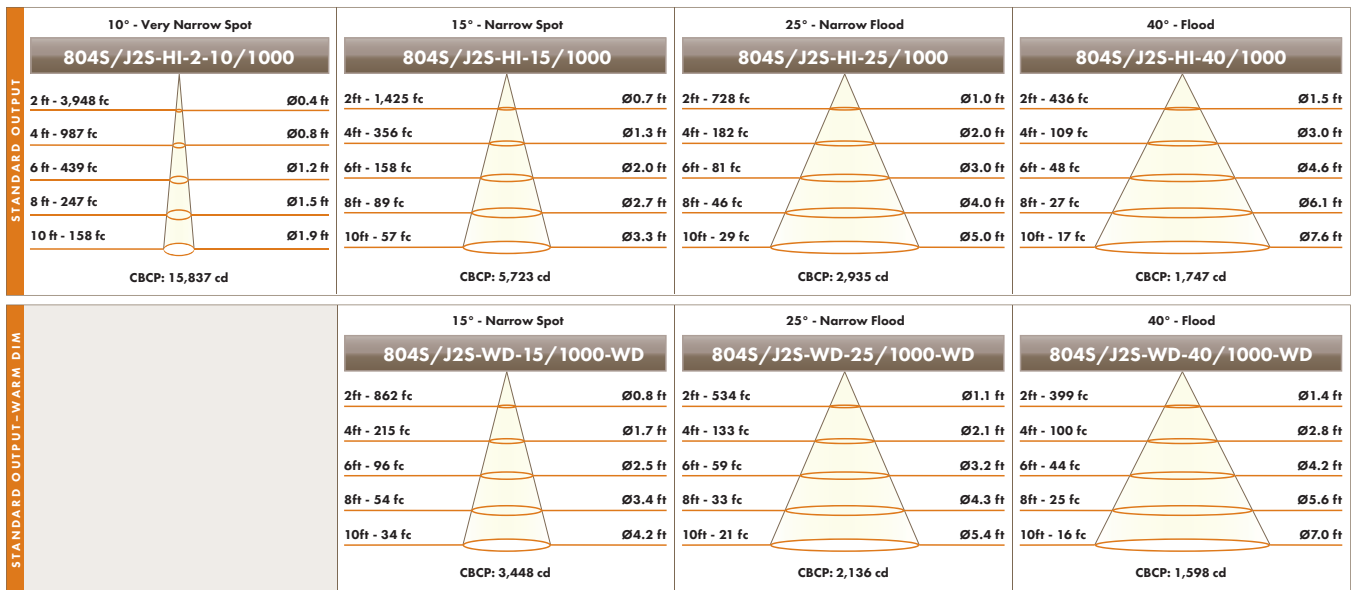

Note: Performance shown for individual lamp modules at 3000K. Output varies by CCT.

804S-4Q/K2S w/ FS/FLS/INS 1.75" APERTURE TRIM - PERFORMANCE SUMMARY

LED	OUTPUT	CCT	CRI	R9	Delivered Lumens	System Wattage	Delivered LPW
HI-27	1000	2700K	94	59	3415-3969	56	61-71
HI	1000	3000K	94	60	3672-4268	56	66-76
HI-2-27	1000	2700K	94	62	4100	58	71
HI-2	1000	3000K	94	63	4408	58	76
WD	1000-WD	3000-1800K	97	81	2960-3484	58	51-60
WD-2	1000-WD	2800-2200K	97	78	2956-3444	58	51-59

Performance summary for HI LED with 15°, 25°, and 40° optic options and HI-2 LED with 10° optic option.

Performance summary for WD LED at 3000K and WD-2 LED at 2800K with 15°, 25°, and 40° optic options.

804S-4Q/K2S w/ FR/FLR/INR 1.75" APERTURE TRIM - PERFORMANCE SUMMARY

LED	OUTPUT	CCT	CRI	R9	Delivered Lumens	System Wattage	Delivered LPW
HI-27	1000	2700K	94	59	3396-3917	56	61-70
HI	1000	3000K	94	60	3652-4212	56	65-75
HI-2-27	1000	2700K	94	62	4060	58	70
HI-2	1000	3000K	94	63	4364	58	75
WD	1000-WD	3000-1800K	97	81	3028-3568	58	52-62
WD-2	1000-WD	2800-2200K	97	78	2972-3508	58	51-60

Performance summary for HI LED with 15°, 25°, and 40° optic options and HI-2 LED with 10° optic option.

Performance summary for WD LED at 3000K and WD-2 LED at 2800K with 15°, 25°, and 40° optic options.

804S-4Q/K2S w/ FS/FLS/INS-LG/NL 2.75" APERTURE TRIM - PERFORMANCE SUMMARY

LED	OUTPUT	CCT	CRI	R9	Delivered Lumens	System Wattage	Delivered LPW
HI-27	1000	2700K	94	59	3698-4166	56	66-74
HI	1000	3000K	94	60	3976-4480	56	71-80
HI-2-27	1000	2700K	94	62	4200	58	72
HI-2	1000	3000K	94	63	4516	58	78
WD	1000-WD	3000-1800K	97	81	3284-3692	58	57-64
WD-2	1000-WD	2800-2200K	97	78	3276-3660	58	56-63

Performance summary for HI LED with 15°, 25°, and 40° optic options and HI-2 LED with 10° optic option.

Performance summary for WD LED at 3000K and WD-2 LED at 2800K with 15°, 25°, and 40° optic options.

804S-4Q/K2S w/ FR/FLR/INR-LG/NL 2.75" APERTURE TRIM - PERFORMANCE SUMMARY

LED	OUTPUT	CCT	CRI	R9	Delivered Lumens	System Wattage	Delivered LPW
HI-27	1000	2700K	94	59	3701-4207	14	66-75
HI	1000	3000K	94	60	3980-4524	14	71-81
HI-2-27	1000	2700K	94	62	4155	14.5	72
HI-2	1000	3000K	94	63	4468	14.5	77
WD	1000-WD	3000-1800K	97	81	3412-3828	14.5	59-66
WD-2	1000-WD	2800-2200K	97	78	3352-3728	14.5	58-64

Performance summary for HI LED with 15°, 25°, and 40° optic options and HI-2 LED with 10° optic option.

Performance summary for WD LED at 3000K and WD-2 LED at 2800K with 15°, 25°, and 40° optic options.

804S/K2S w/ FS/FLS/INS 1.75" APERTURE TRIM - CONE OF LIGHT DIAGRAMS

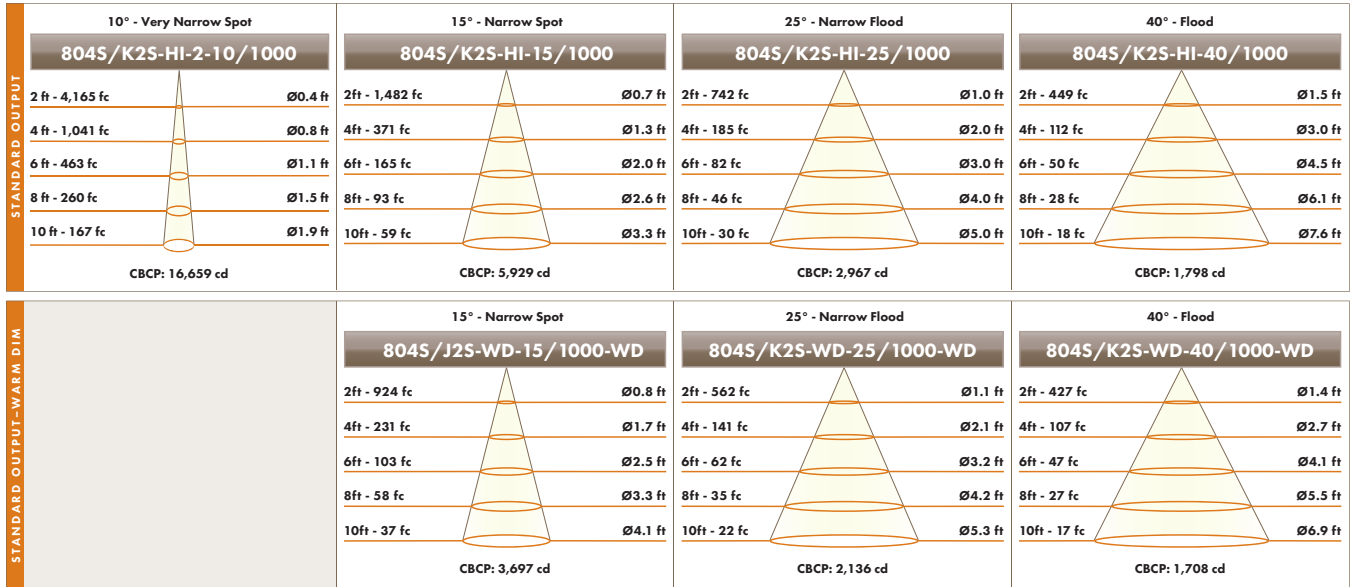

Note: Performance shown for individual lamp modules at 3000K. Output varies by CCT.

804S/K2S w/ FS/FLS/INS-LG/NL 2.75" APERTURE TRIM - CONE OF LIGHT DIAGRAMS

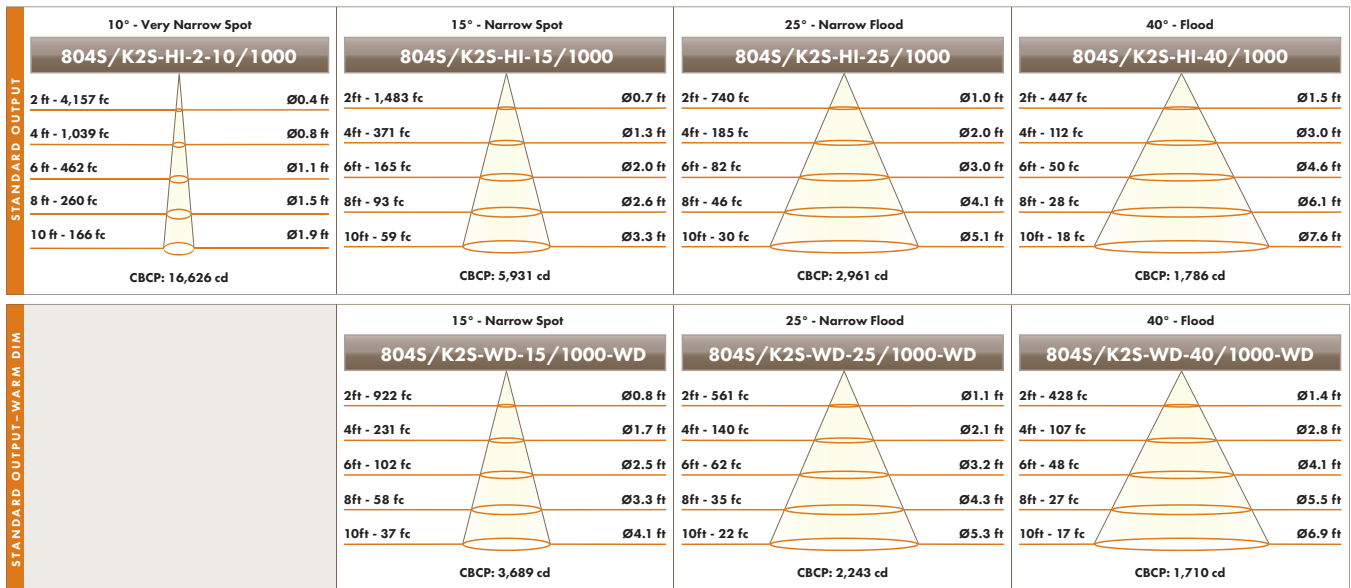

Note: Performance shown for individual lamp modules at 3000K. Output varies by CCT.

804S/J2S w/ 1.75" APERTURE TRIM - OPTICAL OPTIONS AND ACCESSORY PERFORMANCE SUMMARY

OPTIC OPTIONS	LED OPTION	BEAM ENHANCING LENS (OPTIONAL)*				
		+ NSP	+ NFL	+ FL	+ WFL	+ LS
10° Very Narrow Spot	HI-2	14°	25°	44°	47°	13° x 39°
15° Narrow Spot	HI	21°	30°	45°	51°	21° x 40°
15° Narrow Spot	WD/WD-2	24°	31°	36°	50°	25° x 41°
25° Narrow Flood	HI	28°	34°	47°	52°	30° x 39°
25° Narrow Flood	WD/WD-2	29°	34°	46°	52°	32° x 38°
40° Flood	HI	41°	43°	43°	59°	40° x 52°
40° Flood	WD/WD-2	37°	40°	49°	54°	37° x 47°

*Beam enhancing lens used in combination with 10°, 15°, 25°, or 40° optic to achieve desired beam spread.

804S/J2S w/ 2.75" APERTURE TRIM - OPTICAL OPTIONS AND ACCESSORY PERFORMANCE SUMMARY

OPTIC OPTIONS	LED OPTION	BEAM ENHANCING LENS (OPTIONAL)*				
		+ NSP	+ NFL	+ FL	+ WFL	+ LS
10° Very Narrow Spot	HI-2	14°	24°	43°	47°	13° x 39°
15° Narrow Spot	HI	21°	31°	54°	67°	22° x 48°
15° Narrow Spot	WD/WD-2	24°	33°	54°	66°	26° x 48°
25° Narrow Flood	HI	29°	37°	57°	71°	30° x 55°
25° Narrow Flood	WD/WD-2	31°	38°	58°	70°	70° x 71°
40° Flood	HI	42°	45°	46°	80°	41° x 63°
40° Flood	WD/WD-2	39°	44°	64°	77°	76° x 77°

*Beam enhancing lens used in combination with 10°, 15°, 25°, or 40° optic to achieve desired beam spread.

804S/K2S w/ 1.75" APERTURE TRIM - OPTICAL OPTIONS AND ACCESSORY PERFORMANCE SUMMARY

OPTIC OPTIONS	LED OPTION	BEAM ENHANCING LENS (OPTIONAL)*				
		+ NSP	+ NFL	+ FL	+ WFL	+ LS
10° Very Narrow Spot	HI-2	14°	25°	42°	44°	13° x 37°
15° Narrow Spot	HI	21°	31°	49°	58°	22° x 39°
15° Narrow Spot	WD/WD-2	25°	33°	51°	61°	36° x 28°
25° Narrow Flood	HI	29°	36°	53°	64°	30° x 48°
25° Narrow Flood	WD/WD-2	30°	37°	54°	64°	32° x 45°
40° Flood	HI	42°	45°	63°	77°	46° x 52°
40° Flood	WD/WD-2	39°	43°	61°	72°	38° x 58°

*Beam enhancing lens used in combination with 10°, 15°, 25°, or 40° optic to achieve desired beam spread.

804S/K2S w/ 2.75" APERTURE TRIM - OPTICAL OPTIONS AND ACCESSORY PERFORMANCE SUMMARY

OPTIC OPTIONS	LED OPTION	BEAM ENHANCING LENS (OPTIONAL)*				
		+ NSP	+ NFL	+ FL	+ WFL	+ LS
10° Very Narrow Spot	HI-2	14°	25°	44°	47°	13° x 39°
15° Narrow Spot	HI	21°	31°	52°	65°	23° x 40°
15° Narrow Spot	WD/WD-2	25°	33°	54°	68°	26° x 36°
25° Narrow Flood	HI	30°	37°	57°	73°	30° x 53°
25° Narrow Flood	WD/WD-2	31°	38°	58°	76°	33° x 47°
40° Flood	HI	42°	46°	66°	88°	46° x 53°
40° Flood	WD/WD-2	39°	44°	64°	85°	39° x 60°

*Beam enhancing lens used in combination with 10°, 15°, 25°, or 40° optic to achieve desired beam spread.

804S-4Q/J2S w/ FS/FLS-WW-8 1.75" APERTURE TRIM - PERFORMANCE SUMMARY

LED	OUTPUT	OPTIC OPTION	CCT	CRI	R9	Delivered Lumens	System Wattage	Delivered LPW
HI-27	1000	40	2700K	94	57	2466	56	44
HI	1000	40	3000K	94	58	2652	56	47
HI-2-27	1000	10-FL	2700K	94	61	1882	58	32
HI-2	1000	10-FL	3000K	94	62	2024	58	35
WD	1000-WD	40	3000-1800K	97	83	2128	58	37
WD-2	1000-WD	40	2800-2200K	97	78	2112	58	36

Performance summary for **WD** LED at 3000K and **WD-2** LED at 2800K.

804S/J2S-HI-40/1000 w/ FS/FLS TRIM + WW-8 WALL WASH ACCESSORY – FOOTCANDLES ON WALL

DISTANCE TO WALL		2.0 ft						2.5 ft						
ON CENTER SPACING			2.0 ft			2.5 ft			2.5 ft			3.0 ft		
	DISTANCE FROM CEILING	0.5 ft	1.0	1.1	1.0	0.9	0.8	0.9	0.3	0.3	0.3	0.3	0.2	0.3
		1.5 ft	27.3	31.0	27.3	25.1	25.0	25.1	13.4	14.8	13.4	12.6	12.1	12.6
		2.5 ft	28.0	32.6	28.0	25.2	28.8	25.2	19.6	22.8	19.6	18.1	20.0	18.1
		3.5 ft	18.4	20.8	18.4	16.7	19.3	16.7	16.1	18.7	16.1	14.8	17.2	14.8
		4.5 ft	11.3	12.4	11.3	10.5	11.8	10.5	11.2	12.7	11.2	10.4	12.0	10.4
		5.5 ft	7.1	7.6	7.1	6.7	7.3	6.7	7.6	8.4	7.6	7.1	8.0	7.1
		6.5 ft	4.6	4.9	4.6	4.4	4.8	4.4	5.2	5.6	5.2	4.9	5.4	4.9
		7.5 ft	3.1	3.3	3.1	3.0	3.2	3.0	3.6	3.9	3.6	3.5	3.8	3.5
		8.5 ft	2.2	2.3	2.2	2.2	2.3	2.2	2.6	2.8	2.6	2.5	2.7	2.5
9.5 ft	1.6	1.7	1.6	1.6	1.6	1.6	1.9	2.0	1.9	1.9	2.0	1.9		

Note: With **HI** LED option, use 40° optic and 20° aiming angle for optimal performance. Data shown for 3000K CCT.

804S/J2S-WD-40/1000-WD w/ FS/FLS TRIM + WW-8 WALL WASH ACCESSORY – FOOTCANDLES ON WALL

DISTANCE TO WALL		2.0 ft						2.5 ft						
ON CENTER SPACING			2.0 ft			2.5 ft			2.5 ft			3.0 ft		
	DISTANCE FROM CEILING	0.5 ft	1.1	1.4	1.1	1.0	0.9	1.0	0.3	0.4	0.3	0.3	0.3	0.3
		1.5 ft	21.8	25.5	21.8	19.8	20.3	19.8	10.5	12.0	10.5	9.7	9.8	9.7
		2.5 ft	23.8	28.4	23.8	21.2	24.9	21.2	16.3	19.5	16.3	14.9	17.0	14.9
		3.5 ft	16.0	18.2	16.0	14.4	16.9	14.4	13.8	16.3	13.8	12.6	14.9	12.6
		4.5 ft	9.8	10.8	9.8	9.1	10.3	9.1	11.1	11.1	11.1	9.0	10.5	9.0
		5.5 ft	6.2	6.6	6.2	5.8	6.4	5.8	7.3	7.3	7.3	6.2	7.0	6.2
		6.5 ft	4.0	4.2	4.0	3.8	4.1	3.8	4.9	4.9	4.9	4.3	4.7	4.3
		7.5 ft	2.7	2.8	2.7	2.7	2.8	2.7	3.4	3.4	3.4	3.0	3.3	3.0
		8.5 ft	1.9	2.0	1.9	1.9	2.0	1.9	2.4	2.4	2.4	2.2	2.4	2.2
9.5 ft	1.4	1.4	1.4	1.4	1.4	1.4	1.7	1.8	1.7	1.6	1.7	1.6		

Note: With **WD** or **WD-2** LED option, use 40° optic and 20° aiming angle for optimal performance. Data shown for 3000K CCT.

804S-4Q/J2S w/ FR/FLR-WW-8 1.75" APERTURE TRIM - PERFORMANCE SUMMARY

LED	OUTPUT	OPTIC OPTION	CCT	CRI	R9	Delivered Lumens	System Wattage	Delivered LPW
HI-27	1000	40	2700K	94	57	2180	56	39
HI	1000	40	3000K	94	58	2344	56	42
HI-2-27	1000	10-FL	2700K	94	61	1681	58	29
HI-2	1000	10-FL	3000K	94	62	1808	58	31
WD	1000-WD	40	3000-1800K	97	83	1916	58	33
WD-2	1000-WD	40	2800-2200K	97	78	1920	58	33

Performance summary for **WD** LED at 3000K and **WD-2** LED at 2800K.

804S/J2S-HI-40/1000 w/ FR/FLR TRIM + WW-8 WALL WASH ACCESSORY – FOOTCANDLES ON WALL

DISTANCE TO WALL		2.0 ft						2.5 ft						
		ON CENTER SPACING			2.0 ft			2.5 ft			2.5 ft		3.0 ft	
	DISTANCE FROM CEILING	0.5 ft	0.8	0.8	0.8	0.8	0.5	0.8	0.2	0.2	0.2	0.2	0.2	0.2
		1.5 ft	25.1	29.1	25.1	22.8	23.2	22.8	12.1	13.6	12.1	11.3	10.9	11.3
		2.5 ft	26.4	31.0	26.4	23.7	27.1	23.7	18.2	21.4	18.2	16.7	18.7	16.7
		3.5 ft	17.7	20.2	17.7	16.0	18.7	16.0	15.3	17.9	15.3	14.0	16.3	14.0
		4.5 ft	10.9	12.0	10.9	10.1	11.4	10.1	10.8	12.3	10.8	10.0	11.6	10.0
		5.5 ft	6.8	7.3	6.8	6.4	7.1	6.4	7.3	8.1	7.3	6.9	7.8	6.9
		6.5 ft	4.4	4.7	4.4	4.2	4.6	4.2	5.0	5.4	5.0	4.7	5.2	4.7
		7.5 ft	3.0	3.1	3.0	2.9	3.1	2.9	3.5	3.7	3.5	3.3	3.6	3.3
		8.5 ft	2.1	2.2	2.1	2.0	2.1	2.0	2.5	2.6	2.5	2.4	2.6	2.4
	9.5 ft	1.5	1.6	1.5	1.5	1.5	1.5	1.8	1.9	1.8	1.8	1.9	1.8	

Note: With **HI** LED option, use 40° optic and 20° aiming angle for optimal performance. Data shown for 3000K CCT.

804S/J2S-WD-40/1000-WD w/ FR/FLR TRIM + WW-8 WALL WASH ACCESSORY – FOOTCANDLES ON WALL

DISTANCE TO WALL		2.0 ft						2.5 ft						
		ON CENTER SPACING			2.0 ft			2.5 ft			2.5 ft		3.0 ft	
	DISTANCE FROM CEILING	0.5 ft	1.1	1.0	1.1	1.0	0.7	1.0	0.4	0.3	0.4	0.3	0.2	0.3
		1.5 ft	19.3	21.6	19.3	17.5	17.5	17.5	9.1	10.0	9.1	8.5	8.1	8.5
		2.5 ft	22.1	25.3	22.1	19.7	22.3	19.7	14.8	16.8	14.8	13.5	14.6	13.5
		3.5 ft	15.3	17.1	15.3	13.7	16.0	13.7	13.0	14.8	13.0	11.8	13.5	11.8
		4.5 ft	9.5	10.3	9.5	8.7	9.9	8.7	9.3	10.4	9.3	8.6	9.9	8.6
		5.5 ft	6.0	6.4	6.0	5.6	6.2	5.6	6.4	7.0	6.4	6.0	6.7	6.0
		6.5 ft	3.9	4.1	3.9	3.7	4.0	3.7	4.4	4.7	4.4	4.2	4.6	4.2
		7.5 ft	2.6	2.7	2.6	2.5	2.7	2.5	3.1	3.2	3.1	2.9	3.2	2.9
		8.5 ft	1.9	1.9	1.9	1.8	1.9	1.8	2.2	2.3	2.2	2.1	2.3	2.1
	9.5 ft	1.3	1.4	1.3	1.3	1.4	1.3	1.6	1.7	1.6	1.6	1.7	1.6	

Note: With **WD** or **WD-2** LED option, use 40° optic and 20° aiming angle for optimal performance. Data shown for 3000K CCT.