

# LED LIGHT ENGINE: **RETROFIT**

## LAMP MODULE: **J2** or **M2**



526 Portal Street  
Cotati, CA 94931  
USA  
P 707.794.0888  
www.8lighting.com

All No. 8 Lighting fixtures and components are UL Listed to both U.S. and Canadian requirements. No. 8 Lighting trims and lamp modules are protected by one or more U.S. Patents. No. 8 Lighting reserves the right to change details of design, materials, and finish.  
© 2023 No. 8 Lighting  
Doc # 91138-13.1



Project Name	
Date	Type
Prepared By	
Comments	
Catalog #	- - - / / - -

### PRODUCT FEATURES



**801 - NON I.C.**



**802 - I.C.**



**803 - I.C.**

**800 SERIES HOUSINGS**  
(Legacy models)



**J2 - LED ADJUSTABLE**

---



**M2-5      M2-R**

**M2 - LED MIRROR REFLECTOR**





**800 SERIES TRIMS**  
(Specified separately)

### 800 SERIES RETROFIT SPECIFICATION SUMMARY

LED Option	Static White Standard Output				Warm Dimming	
	HI-2-27	HI-2	HI-27	HI	WD	WD-2
Delivered Lumens	971	1044	968	1041	837	834
System Wattage	14.5	14.5	14	14	14.5	14.5
Efficacy	67	72	69	74	58	58
CRI	94	94	94	94	97	97
R9	62	63	59	60	82	77
CCT	2700K	3000K	2700K	3000K	3000-1800K	2800-2200K
Optic Options	10		15, 25, 40		15, 25, 40	
Color Consistency	2-Step				3-Step	
Optical Accessories	Narrow, Medium, Wide, Extra Wide, Linear Spread, and 2400K, 2700K, 3500K Color Filters					
Adjustability	J2 - 0-45° Tilt, 360° Rotation, Lockable / M2 - 35-90° Rotation, Lockable					
Dimming Options	<1% Forward/Reverse Phase (120v), 0.1/1% 0-10v (120-277v), 0.1/1% DALI (120-277v), 0.1/1% EcoSystem (120 or 277v)					
Trim Options	Round/Square Flat, Round/Square Bevel, Round/Square Inset, Round/Square Wall-Wash					
Finish Options	White, Oil-Rubbed Bronze, Polished Nickel, Satin Nickel, Black					
Trim Mounting Options	Flanged, Flangeless Sheetrock, Flangeless Wood					
Trim Lens Options	UL Wet Listed and IP54 Rated - Clear, Soft Focus, Wall-Wash					
Housing Options	New Construction: Type Non-IC, Type IC-CP Rated CCEA Approved Air-Tight					

Data shown for J2 Lamp Modules with FS/FLS/INS-LG/NL trims.  
Warm Dimming data shown for 3000K and 2800K.  
See Performance Summaries for additional information.  
800 Series Trims specified separately.

PRODUCT SPECIFIER/PRODUCT ORDER NUMBER

LAMP MODULE OPTIONS	LED OPTIONS	OPTIC OPTIONS	OPTICAL ACCESSORIES (Optional)	TRIM FINISH (Leave blank for J2 module)	DIMMING OPTIONS	OUTPUT	EXISTING HOUSING TYPE*
 <p><b>J2</b> LED ADJUSTABLE 45° tilt, full 360° rotation with tool-less locking vertical and horizontal adjustment</p> <hr/>  <p><b>M2-S*</b> LED MIRROR REFLECTOR module w/integral 4" SQUARE trim plate fits into square Seamless Series™ trim assemblies</p> <hr/>  <p><b>M2-R*</b> LED MIRROR REFLECTOR module w/integral 4" ROUND trim plate fits into round Seamless Series™ trim assemblies</p> <p>*M2 modules require trim finish selection.</p>	<p><b>HI-27</b> 2700K White LED</p> <p><b>HI</b> 3000K White LED</p> <p><b>HI-2-27*</b> 2700K White LED</p> <p><b>HI-2*</b> 3000K White LED</p> <p><b>WD</b> 3000-1800K Warm Dim LED</p> <p><b>WD-2</b> 2800-2200K Warm Dim LED</p> <p>*For use with 10° optic only.</p>	<p><b>10*</b> 10° Very Narrow Spot</p> <p><b>15</b> 15° Narrow Spot</p> <p><b>25</b> 25° Narrow Flood</p> <p><b>40</b> 40° Flood</p> <p>*For use with HI-2 LED only.</p>	<p><b>NSP</b> Narrow Softening Lens</p> <p><b>NFL</b> Medium Softening Lens</p> <p><b>FL</b> Wide Softening Lens</p> <p><b>WFL</b> Extra Wide Softening Lens</p> <p><b>LS</b> Linear Spread Lens</p> <p><b>CF24*</b> 2400K Color Filtering Lens</p> <p><b>CF27*</b> 2700K Color Filtering Lens</p> <p><b>CF35*</b> 3500K Color Filtering Lens</p> <p>*For use with HI and HI-2 3000K LED options only.</p>	<p><b>WH</b> WHITE</p> <p><b>OB*</b> OIL-RUBBED BRONZE</p> <p>*Specialty finish</p>	<p><b>PR1-8</b> Premium Forward or Reverse-Phase &lt;1% Dimming</p> <p><b>EL1-8†</b> EldoLED 0-10v 1% Dimming</p> <p><b>EL1-01-8†</b> EldoLED 0-10v 0.1% Dimming</p> <p><b>EL2-8†</b> EldoLED DALI 1% Dimming</p> <p><b>EL2-01-8†</b> EldoLED DALI 0.1% Dimming</p> <p><b>LU2-8†</b> Lutron Hi-Lume LDE1 Eco-System 1% Dimming</p> <p><b>LU4-8</b> Lutron Hi-Lume PEQOE EcoSystem 0.1% Dimming</p> <p>†Not available for use with housing models 801 or 802.</p>	<p><b>1000</b> Standard output</p> <p><b>1000-WD</b> Standard output – Warm Dimming</p>	<p><b>801</b> New Construction – Non-I.C.</p> <p><b>802</b> New Construction – Airtight-I.C.</p> <p><b>803</b> New Construction – Airtight-I.C.</p> <p>* Existing housing type required for correct dimming driver mounting configuration.</p>

**Lamp Module, LED, Optic Option, and Accessory Notes**

**J2** Fully adjustable lamp module features patented tool-free adjustment mechanism. Use for adjustable accent, wall wash\*, and general lighting applications. \*For wall washing: specify 40° optic option with **HI**, **WD**, or **WD-2** LED or 10° optic option and **FL** lens with **HI-2** LED. Requires **WW-8** wall wash accessory, specified with **FS/FR** or **FLS/FLR** (1.75" aperture) **800 Series** trims. **M2** Adjustable lamp module features 35-90° vertical\* and 90° horizontal adjustment. \*Vertical adjustment range based on ceiling thickness and trim type used. See Page 7 for additional details. Use on sloped ceilings for adjustable accent, wall wash, and general lighting applications. Lamp module assembly includes either a SQUARE or ROUND trim plate for use with **800 Series Seamless** trims. To ensure fixture to fixture color consistency, use of the same LED option with adjacent fixtures is recommended. One field interchangeable optic option included standard. Up to two additional optical accessories can be accommodated.

**Dimming and Output Option Notes**

0-10v dimming options are configured for linear control. DALI dimming options are configured for logarithmic control. No.8 Lighting conducts extensive testing to establish compatibility with many dimmer types. For a complete list of compatible dimmers, see [8lighting.com/resources-downloads](http://8lighting.com/resources-downloads). Outputs vary depending on LED type, trim type, and optical accessories used. For photometric files in PDF and IES formats, see [8lighting.com/800-series-photometry](http://8lighting.com/800-series-photometry).

**Installation Notes**

Ambient temperatures in ceiling space should not exceed 40°C (104°F) during normal operation. For models with **EL1/EL1-01-8**, **EL2/EL2-01-8**, or **LU2-8** dimming options, ambient temperatures should not exceed 25°C (77°F).

**Warranty**

All No. 8 Lighting products are covered by a 5 year limited warranty. Products installed in residential steam applications are covered by a 2 year limited warranty. For specific warranty details and limitations, see [8lighting.com/resources-downloads](http://8lighting.com/resources-downloads).

## J2 LAMP MODULE w/ FS/FLS/INS 1.75" APERTURE TRIM - PERFORMANCE SUMMARY

LED	OUTPUT	CCT	CRI	R9	Delivered Lumens	System Wattage	Delivered LPW
HI-27	1000	2700K	94	59	737-883	14	53-63
HI	1000	3000K	94	60	792-949	14	57-68
HI-2-27	1000	2700K	94	62	955	14.5	66
HI-2	1000	3000K	94	63	1027	14.5	71
WD	1000-WD	3000-1800K	97	82	602-735	14.5	42-51
WD-2	1000-WD	2800-2200K	96	78	598-731	14.5	41-50

Performance summary for HI LED with 15°, 25°, and 40° optic options and HI-2 LED with 10° optic option.  
Performance summary for WD LED at 3000K and WD-2 LED at 2800K with 15°, 25°, and 40° optic options.

## J2 LAMP MODULE w/ FR/FLR/INR 1.75" APERTURE TRIM - PERFORMANCE SUMMARY

LED	OUTPUT	CCT	CRI	R9	Delivered Lumens	System Wattage	Delivered LPW
HI-27	1000	2700K	94	59	714-875	14	51-63
HI	1000	3000K	94	60	768-941	14	55-67
HI-2-27	1000	2700K	94	62	946	14.5	65
HI-2	1000	3000K	94	63	1017	14.5	70
WD	1000-WD	3000-1800K	97	81	600-739	14.5	41-51
WD-2	1000-WD	2800-2200K	97	77	595-739	14.5	41-51

Performance summary for HI LED with 15°, 25°, and 40° optic options and HI-2 LED with 10° optic option.  
Performance summary for WD LED at 3000K and WD-2 LED at 2800K with 15°, 25°, and 40° optic options.

## J2 LAMP MODULE w/ 1.75" APERTURE TRIM - OPTICAL OPTIONS AND ACCESSORY PERFORMANCE SUMMARY

OPTIC OPTIONS	LED OPTION	BEAM ENHANCING LENS (OPTIONAL)*				
		+ NSP	+ NFL	+ FL	+ WFL	+ LS
10° Very Narrow Spot	HI-2	14°	25°	44°	47°	13° x 39°
15° Narrow Spot	HI	21°	30°	45°	51°	21° x 40°
15° Narrow Spot	WD/WD-2	24°	31°	36°	50°	25° x 41°
25° Narrow Flood	HI	28°	34°	47°	52°	30° x 39°
25° Narrow Flood	WD/WD-2	29°	34°	46°	52°	32° x 38°
40° Flood	HI	41°	43°	43°	59°	40° x 52°
40° Flood	WD/WD-2	37°	40°	49°	54°	37° x 47°

\*Beam enhancing lens used in combination with 10°, 15°, 25°, or 40° optic to achieve desired beam spread.

## J2 LAMP MODULE w/ FS/FLS/INS 1.75" APERTURE TRIM - CONE OF LIGHT DIAGRAMS

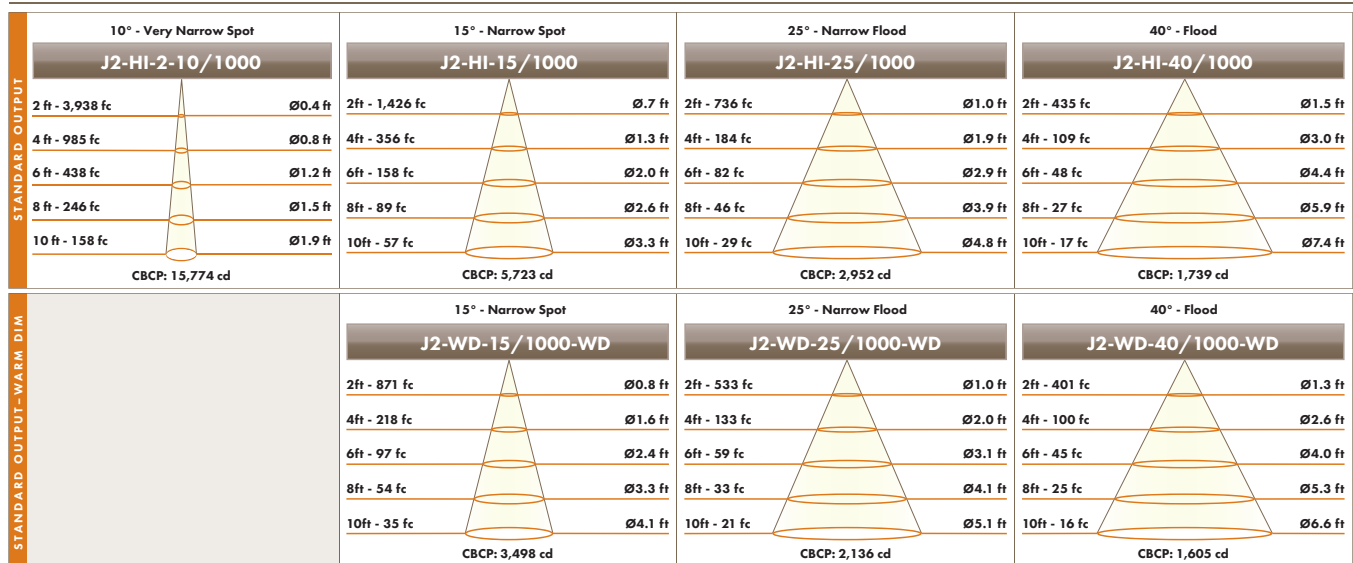

Performance shown for 3000K. Output varies by CCT.

## J2 LAMP MODULE w/ **FS/FLS/INS-LG/NL 2.75"** APERTURE TRIM - PERFORMANCE SUMMARY

LED	OUTPUT	CCT	CRI	R9	Delivered Lumens	System Wattage	Delivered LPW
<b>HI-27</b>	1000	2700K	94	59	838-968	14	60-69
<b>HI</b>	1000	3000K	94	60	901-1041	14	64-74
<b>HI-2-27</b>	1000	2700K	94	62	971	14.5	67
<b>HI-2</b>	1000	3000K	94	63	1044	14.5	72
<b>WD</b>	1000-WD	3000-1800K	97	82	727-837	14.5	50-58
<b>WD-2</b>	1000-WD	2800-2200K	96	77	728-834	14.5	50-58

Performance summary for **HI** LED with 15°, 25°, and 40° optic options and **HI-2** LED with 10° optic option.  
 Performance summary for **WD** LED at 3000K and **WD-2** LED at 2800K with 15°, 25°, and 40° optic options.

## J2 LAMP MODULE w/ **FR/FLR/INR-LG/NL 2.75"** APERTURE TRIM - PERFORMANCE SUMMARY

LED	OUTPUT	CCT	CRI	R9	Delivered Lumens	System Wattage	Delivered LPW
<b>HI-27</b>	1000	2700K	94	59	846-976	14	60-70
<b>HI</b>	1000	3000K	94	60	910-1049	14	65-75
<b>HI-2-27</b>	1000	2700K	94	62	976	14.5	67
<b>HI-2</b>	1000	3000K	94	63	1049	14.5	72
<b>WD</b>	1000-WD	3000-1800K	97	81	745-862	14.5	51-59
<b>WD-2</b>	1000-WD	2800-2200K	97	77	741-849	14.5	51-59

Performance summary for **HI** LED with 15°, 25°, and 40° optic options and **HI-2** LED with 10° optic option.  
 Performance summary for **WD** LED at 3000K and **WD-2** LED at 2800K with 15°, 25°, and 40° optic options.

## J2 LAMP MODULE w/ **2.75"** APERTURE TRIM - OPTICAL OPTIONS AND ACCESSORY PERFORMANCE SUMMARY

OPTIC OPTIONS	LED OPTION	BEAM ENHANCING LENS (OPTIONAL)*				
		+ NSP	+ NFL	+ FL	+ WFL	+ LS
10° Very Narrow Spot	HI-2	14°	24°	43°	47°	13° x 39°
15° Narrow Spot	HI	21°	31°	54°	67°	22° x 48°
15° Narrow Spot	WD/WD-2	24°	33°	54°	66°	26° x 48°
25° Narrow Flood	HI	29°	37°	57°	71°	30° x 55°
25° Narrow Flood	WD/WD-2	31°	38°	58°	70°	70° x 71°
40° Flood	HI	42°	45°	46°	80°	41° x 63°
40° Flood	WD/WD-2	39°	44°	64°	77°	76° x 77°

\*Beam enhancing lens used in combination with 10°, 15°, 25°, or 40° optic to achieve desired beam spread.

## J2 LAMP MODULE w/ **FS/FLS/INS-LG/NL 2.75"** APERTURE TRIM - CONE OF LIGHT DIAGRAMS

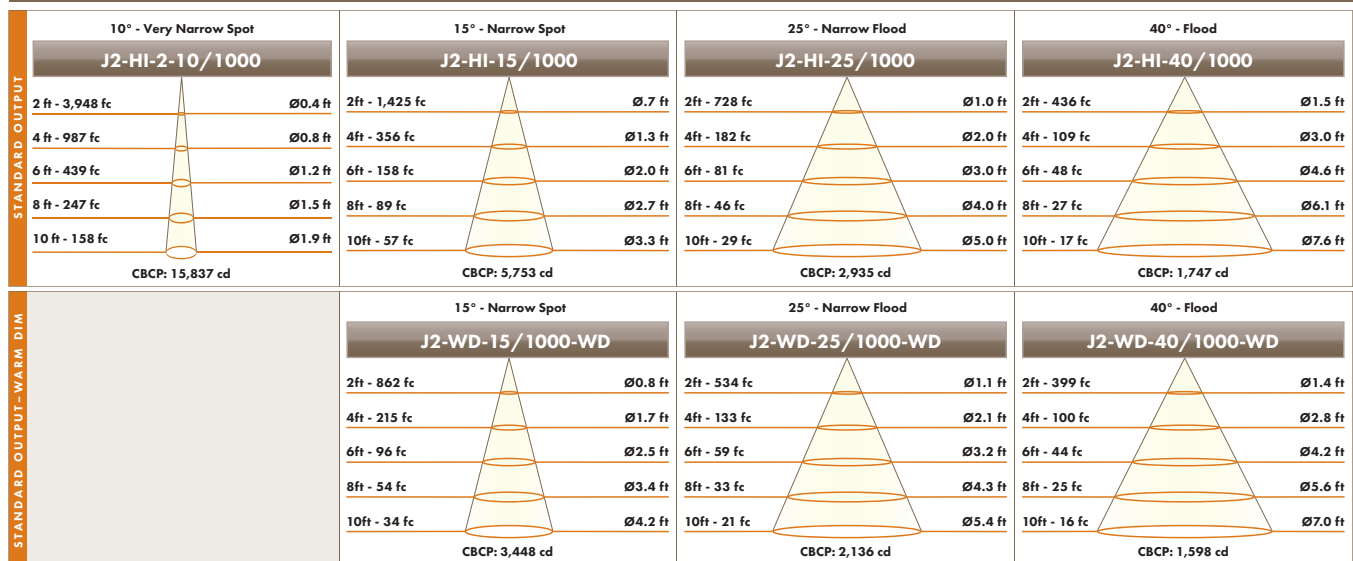

Performance shown for 3000K. Output varies by CCT.

**J2 LAMP MODULE w/ FS/FLS TRIM + WW-8 WALL WASH ACCESSORY - PERFORMANCE SUMMARY**

LED	OUTPUT	OPTIC OPTION	CCT	CRI	R9	Delivered Lumens	System Wattage	Delivered LPW
HI-27	1000	40	2700K	94	57	617	14	44
HI	1000	40	3000K	94	58	663	14	47
HI-2-27	1000	10-FL	2700K	94	61	471	14.5	32
HI-2	1000	10-FL	3000K	94	62	506	14.5	35
WD	1000-WD	40	3000-1800K	97	83	532	14.5	37
WD-2	1000-WD	40	2800-2200K	97	78	528	14.5	36

Performance summary for **WD** LED at 3000K and **WD-2** LED at 2800K.

**J2-HI-40 LAMP MODULE w/ FS/FLS TRIM + WW-8 WALL WASH ACCESSORY – FOOTCANDLES ON WALL**

DISTANCE TO WALL		2.0 ft						2.5 ft						
		ON CENTER SPACING			2.0 ft			2.5 ft		2.5 ft			3.0 ft	
	DISTANCE FROM CEILING	0.5 ft	1.0	1.1	1.0	0.9	0.8	0.9	0.3	0.3	0.3	0.3	0.2	0.3
		1.5 ft	27.3	31.0	27.3	25.1	25.0	25.1	13.4	14.8	13.4	12.6	12.1	12.6
		2.5 ft	28.0	32.6	28.0	25.2	28.8	25.2	19.6	22.8	19.6	18.1	20.0	18.1
		3.5 ft	18.4	20.8	18.4	16.7	19.3	16.7	16.1	18.7	16.1	14.8	17.2	14.8
		4.5 ft	11.3	12.4	11.3	10.5	11.8	10.5	11.2	12.7	11.2	10.4	12.0	10.4
		5.5 ft	7.1	7.6	7.1	6.7	7.3	6.7	7.6	8.4	7.6	7.1	8.0	7.1
		6.5 ft	4.6	4.9	4.6	4.4	4.8	4.4	5.2	5.6	5.2	4.9	5.4	4.9
		7.5 ft	3.1	3.3	3.1	3.0	3.2	3.0	3.6	3.9	3.6	3.5	3.8	3.5
		8.5 ft	2.2	2.3	2.2	2.2	2.3	2.2	2.6	2.8	2.6	2.5	2.7	2.5
9.5 ft	1.6	1.7	1.6	1.6	1.6	1.6	1.9	2.0	1.9	1.9	2.0	1.9		

Note: With **HI** LED option, use 40° optic and 20° aiming angle for optimal performance. Data shown for 3000K CCT.

**J2-WD-40 LAMP MODULE w/ FS/FLS TRIM + WW-8 WALL WASH ACCESSORY – FOOTCANDLES ON WALL**

DISTANCE TO WALL		2.0 ft						2.5 ft						
		ON CENTER SPACING			2.0 ft			2.5 ft		2.5 ft			3.0 ft	
	DISTANCE FROM CEILING	0.5 ft	1.1	1.4	1.1	1.0	0.9	1.0	0.3	0.4	0.3	0.3	0.3	0.3
		1.5 ft	21.8	25.5	21.8	19.8	20.3	19.8	10.5	12.0	10.5	9.7	9.8	9.7
		2.5 ft	23.8	28.4	23.8	21.2	24.9	21.2	16.3	19.5	16.3	14.9	17.0	14.9
		3.5 ft	16.0	18.2	16.0	14.4	16.9	14.4	13.8	16.3	13.8	12.6	14.9	12.6
		4.5 ft	9.8	10.8	9.8	9.1	10.3	9.1	11.1	11.1	11.1	9.0	10.5	9.0
		5.5 ft	6.2	6.6	6.2	5.8	6.4	5.8	7.3	7.3	7.3	6.2	7.0	6.2
		6.5 ft	4.0	4.2	4.0	3.8	4.1	3.8	4.9	4.9	4.9	4.3	4.7	4.3
		7.5 ft	2.7	2.8	2.7	2.7	2.8	2.7	3.4	3.4	3.4	3.0	3.3	3.0
		8.5 ft	1.9	2.0	1.9	1.9	2.0	1.9	2.4	2.4	2.4	2.2	2.4	2.2
9.5 ft	1.4	1.4	1.4	1.4	1.4	1.4	1.7	1.8	1.7	1.6	1.7	1.6		

Note: With **WD** or **WD-2** LED option, use 40° optic and 20° aiming angle for optimal performance. Data shown for 3000K CCT.

**J2 LAMP MODULE w/ FR/FLR TRIM + WW-8 WALL WASH ACCESSORY - PERFORMANCE SUMMARY**

LED	OUTPUT	OPTIC OPTION	CCT	CRI	R9	Delivered Lumens	System Wattage	Delivered LPW
HI-27	1000	40	2700K	94	57	545	14	39
HI	1000	40	3000K	94	58	586	14	42
HI-2-27	1000	10-FL	2700K	94	61	420	14.5	29
HI-2	1000	10-FL	3000K	94	62	452	14.5	31
WD	1000-WD	40	3000-1800K	97	82	479	14.5	33
WD-2	1000-WD	40	2800-2200K	97	78	480	14.5	33

Performance summary for **WD** LED at 3000K and **WD-2** LED at 2800K.

**J2-HI-40 LAMP MODULE w/ FR/FLR TRIM + WW-8 WALL WASH ACCESSORY – FOOTCANDLES ON WALL**

DISTANCE TO WALL		2.0 ft						2.5 ft						
ON CENTER SPACING		⊙	2.0 ft	⊙	⊙	2.5 ft	⊙	⊙	2.5 ft	⊙	⊙	3.0 ft	⊙	
	DISTANCE FROM CEILING	0.5 ft	0.8	0.8	0.8	0.8	0.5	0.8	0.2	0.2	0.2	0.2	0.2	0.2
		1.5 ft	25.1	29.1	25.1	22.8	23.2	22.8	12.1	13.6	12.1	11.3	10.9	11.3
		2.5 ft	26.4	31.0	26.4	23.7	27.1	23.7	18.2	21.4	18.2	16.7	18.7	16.7
		3.5 ft	17.7	20.2	17.7	16.0	18.7	16.0	15.3	17.9	15.3	14.0	16.3	14.0
		4.5 ft	10.9	12.0	10.9	10.1	11.4	10.1	10.8	12.3	10.8	10.0	11.6	10.0
		5.5 ft	6.8	7.3	6.8	6.4	7.1	6.4	7.3	8.1	7.3	6.9	7.8	6.9
		6.5 ft	4.4	4.7	4.4	4.2	4.6	4.2	5.0	5.4	5.0	4.7	5.2	4.7
		7.5 ft	3.0	3.1	3.0	2.9	3.1	2.9	3.5	3.7	3.5	3.3	3.6	3.3
		8.5 ft	2.1	2.2	2.1	2.0	2.1	2.0	2.5	2.6	2.5	2.4	2.6	2.4
9.5 ft	1.5	1.6	1.5	1.5	1.5	1.5	1.8	1.9	1.8	1.8	1.9	1.8		

Note: With **HI** LED option, use 40° optic and 20° aiming angle for optimal performance. Data shown for 3000K CCT.

**J2-WD-40 LAMP MODULE w/ FR/FLR TRIM + WW-8 WALL WASH ACCESSORY – FOOTCANDLES ON WALL**

DISTANCE TO WALL		2.0 ft						2.5 ft						
ON CENTER SPACING		⊙	2.0 ft	⊙	⊙	2.5 ft	⊙	⊙	2.5 ft	⊙	⊙	3.0 ft	⊙	
	DISTANCE FROM CEILING	0.5 ft	1.1	1.0	1.1	1.0	0.7	1.0	0.4	0.3	0.4	0.3	0.2	0.3
		1.5 ft	19.3	21.6	19.3	17.5	17.5	17.5	9.1	10.0	9.1	8.5	8.1	8.5
		2.5 ft	22.1	25.3	22.1	19.7	22.3	19.7	14.8	16.8	14.8	13.5	14.6	13.5
		3.5 ft	15.3	17.1	15.3	13.7	16.0	13.7	13.0	14.8	13.0	11.8	13.5	11.8
		4.5 ft	9.5	10.3	9.5	8.7	9.9	8.7	9.3	10.4	9.3	8.6	9.9	8.6
		5.5 ft	6.0	6.4	6.0	5.6	6.2	5.6	6.4	7.0	6.4	6.0	6.7	6.0
		6.5 ft	3.9	4.1	3.9	3.7	4.0	3.7	4.4	4.7	4.4	4.2	4.6	4.2
		7.5 ft	2.6	2.7	2.6	2.5	2.7	2.5	3.1	3.2	3.1	2.9	3.2	2.9
		8.5 ft	1.9	1.9	1.9	1.8	1.9	1.8	2.2	2.3	2.2	2.1	2.3	2.1
9.5 ft	1.3	1.4	1.3	1.3	1.4	1.3	1.6	1.7	1.6	1.6	1.7	1.6		

Note: With **WD** or **WD-2** LED option, use 40° optic and 20° aiming angle for optimal performance. Data shown for 3000K CCT.

## M2 LAMP MODULE w/ FS/FLS/FR/FLR TRIM - PERFORMANCE SUMMARY

LED	OUTPUT	CCT	CRI	R9	Delivered Lumens	System Wattage	Delivered LPW
<b>HI-27</b>	1000	2700K	93	55	565-686	14	40-49
<b>HI</b>	1000	3000K	93	56	607-738	14	43-53
<b>HI-2-27</b>	1000	2700K	93	58	797	14.5	55
<b>HI-2</b>	1000	3000K	93	59	857	14.5	59
<b>WD</b>	1000-WD	3000-1800K	97	78	470-569	14.5	32-39
<b>WD-2</b>	1000-WD	2800-2200K	96	74	469-560	14.5	32-39

Performance summary for **HI** LED with 15°, 25°, and 40° optic options and **HI-2** LED with 10° optic option.  
 Performance summary for **WD** LED at 3000K and **WD-2** LED at 2800K with 15°, 25°, and 40° optic options.

## M2 LAMP MODULE - VERTICAL AIMING RANGE

### SEAMLESS SERIES

PLASTER/SHEETROCK CEILING APPLICATIONS

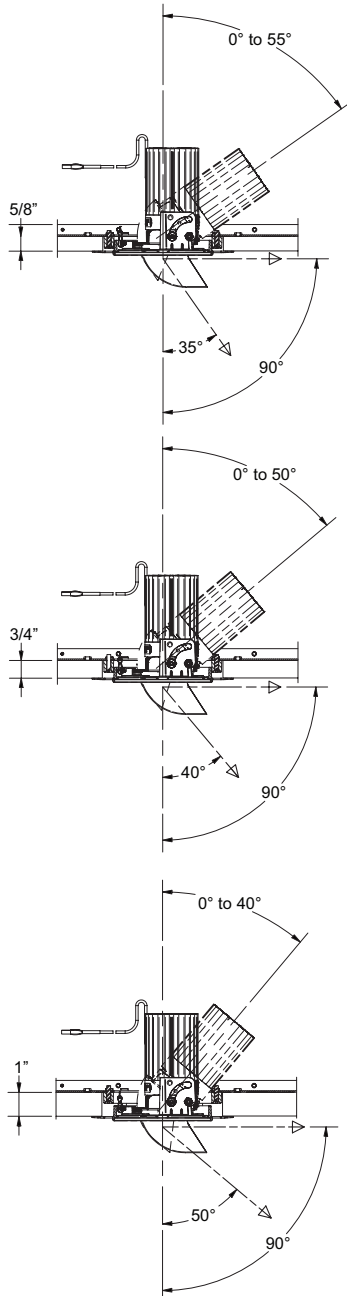

### SEAMLESS SERIES

WOOD/STONE CEILING APPLICATIONS

