

HOUSING: **804S-2** - LOW PROFILE **MULTI-LAMP** LAMP MODULE: **J2S** or **K2S** | LED



eight
LIGHTING

526 Portal Street
Cotati, CA 94931
USA
P 707.794.0888
F 707.795.4379
www.8lighting.com

All No. 8 Lighting fixtures and components are UL/CSA listed. Select 804S Series fixtures and components are also CE Certified. No. 8 Lighting trims and lamp modules are protected by one or more U.S. Patents. No. 8 Lighting reserves the right to change details of design, materials, and finish.
© 2021 No. 8 Lighting
Doc # 91160-12.3



Project Name	
Date	Type
Prepared By	
Catalog # 804S-2 / - /	
/ L1 - - - / L2 - - -	

PRODUCT FEATURES

Housing

- **804S-2** Low-Profile IC-Rated for direct contact with standard or spray-foam thermal insulation with a max combined R-Value of R42 (may also be installed in Non-IC applications). Meets Washington State Airtight Standard WAC 51-11-0502 and in accordance with ASTM E283 to reduce energy loss. CCEA plenum rated for City of Chicago environmental air spaces.
 - Accepts two **J2S** or **K2S** LED Lamp Modules and two **800 Series** Trim Assemblies.
- Note: Minimum 4-1/2" ceiling space required when used with INSET and BEVEL Series Trim Assemblies.

Dimming Options

- **DIM1-8** Phase dimming LED driver with 120v/60Hz input. Dimmable to 1% using compatible Forward or Reverse-Phase dimmers.
- **DIM2-8** 0-10v LED dimming driver with 120-277v/60Hz input. Dimmable to 1% using compatible 0-10v dimmers.
- **PR1-8** Premium phase dimming LED driver with 120v/60Hz input. Dimmable to 0.1% using compatible Forward or Reverse-Phase dimmers.
- **EL1-8** EdoLED 0-10v LED dimming driver with 120-277v/60Hz input. Dimmable to 1% using compatible 0-10v dimmers.
- **EL2-8** EdoLED DALI dimming LED driver with 120-277v/60Hz input. Dimmable to 1% using compatible DALI dimmers.
- **LU1-8** Lutron Hi-lume **LTEA2W** 1% 2-wire LED driver (120v Forward Phase only). 120v/60Hz input.
- **LU2-8** Lutron Hi-lume **LDE1** 1% EcoSystem LED driver with Soft-on, Fade-to-Black. 120-277v/60Hz input.
- **LU4-8** Lutron Hi-lume Premier **PEQOE** 0.1% EcoSystem LED driver with Soft-on, Fade-to-Black. 120-277v/60Hz input.

For complete list of compatible dimmers, see 8lighting.com/resources-downloads **Output***

- **700** Low output. Delivers up to 1642 lumens.
 - **1000** Standard output. Delivers up to 2174 lumens.
 - **1000-WD** Standard output - Warm Dimming. Delivers up to 1810 lumens.
- *Output varies depending on lamp module, LED type, trim type, and optical accessories used (see page 3 for additional details).

For photometric files in PDF and IES formats, see 8lighting.com/800-series-photometry

Mounting Accessories

- **BH** Bar Hangers for joist mounting.
- **TBC-BH** T-BAR Mounting Clips + Bar Hangers for T-Bar mounting.
- **PMB** Panel Mounting Brackets (set of two) for direct mounting to wood panels.

Lamp Module Options

- **J2S** Fully adjustable lamp module with 0-45° vertical and 360° horizontal adjustment. Use for adjustable accent, wall wash*, and general lighting applications. *For wall washing: specify 40° optic option with **HI**, **WD**, or **WD-2** LED or 10° optic option and FL lens with **HI-2** LED. Requires WW-8 wall wash accessory, specified with **FS/FR** or **FLS/FLR** (1.75" aperture) **800 Series** trims.
- **K2S** Fixed position lamp module. Use for general lighting applications.
- Optic options include: 10°, 15°, 25°, and 40°.

Note: 10° optic option requires **HI-2** LED and is not field interchangeable with **HI**, **WD**, or **WD-2** LED options.

LED Options

- **HI** 3000K 92+ CRI White LED. Minimum 2-Step color binning.
 - **HI-2** 3000K 92+ CRI White LED. Minimum 2-Step color binning. Note: For use with 10° optic option only.
 - **WD** 3000-1800K 97+ CRI Warm Dim LED. Minimum 3-Step color binning.
 - **WD-2** 2800-2200K 95+ CRI Warm Dim LED. Minimum 3-Step color binning.
- Note: To ensure fixture to fixture color consistency, use of the same LED option with adjacent fixtures is recommended.

Optic Options and Accessories

- Optic options include: 10°, 15°, 25°, and 40°. Note: 10° optic option for use with **HI-2** LED option only.
- Optional beam enhancing lens accessories include: **NSP**-Narrow Softening, **NFL**-Medium Softening, **FL**-Wide Softening, **WFL**-Extra Wide Softening, and **LS**-Linear Spread.
- Optional color filtering lens accessories include: **CF24**-2400K, **CF27**-2700K, & **CF35**-3500K.

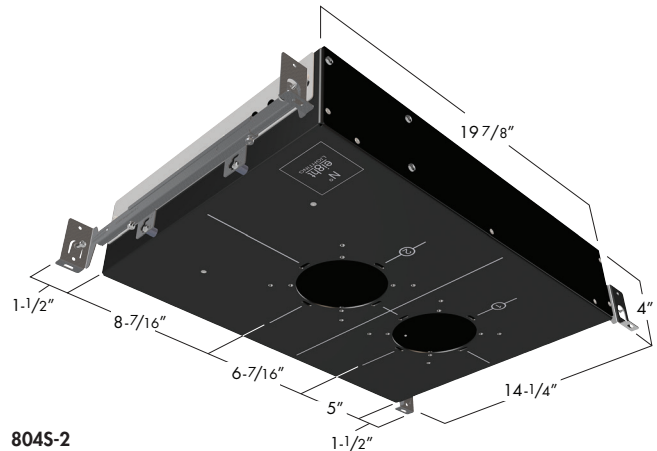

804S-2
LOW PROFILE MULTI-LAMP HOUSING
(shown with BH mounting accessory)

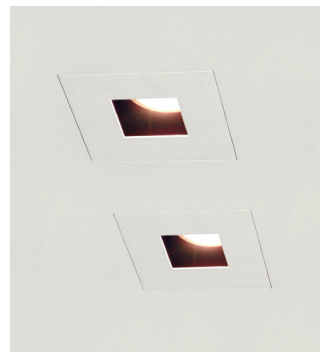

804S-2 with **FS-P** trim



804S-2 with **FR-P** trim



J2S – LED ADJUSTABLE



K2S – LED FIXED POSITION

PRODUCT SPECIFIER/PRODUCT ORDER NUMBER

804S-2	/		-		/	
HOUSING	/	DIMMING OPTIONS	-	OUTPUT	/	MOUNTING ACCESSORIES

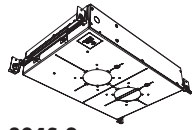

804S-2
New Construction – Low-Profile AIRTIGHT - IC and Non-IC Rated
14 1/4"W x 19 7/8"L x 4"H
*Add 3" to length to accommodate mounting accessories

- DIM1-8**
Forward or Reverse-Phase 1% Dimming
 - DIM2-8**
0-10v 1% Dimming
 - PR1-8***
Premium Forward or Reverse-Phase 0.1% Dimming
 - EL1-8†**
EldoLED 0-10v 1% Dimming
 - EL2-8†**
EldoLED DALI 1% Dimming
 - LU1-8**
Lutron Hi-Lume Forward-Phase 1% Dimming
 - LU2-8**
Lutron Hi-Lume Eco System 1% Dimming
 - LU4-8**
Lutron 0.1% EcoSystem Dimming
- *Not available with WD or WD-2 LED options
† Also CE Certified with HI or HI-2 LED options

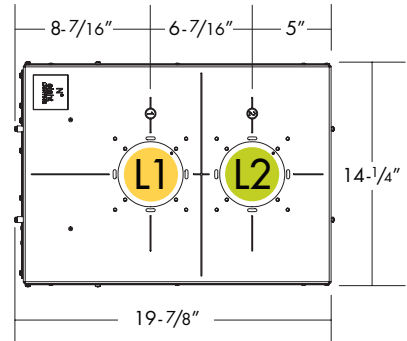

- 700**
Low output
- 1000**
Standard output
- 1000-WD**
Standard output – Warm Dimming

- BH**
Bar Hangers
- TBC-BH**
T-Bar Mounting Clips + Bar Hangers
- PMB**
Panel Mounting Brackets

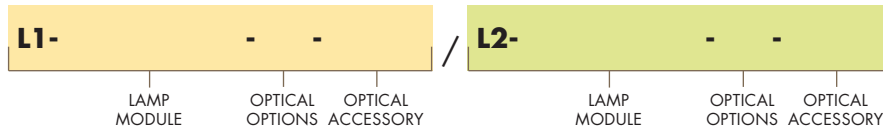

A combination Lamp Module with desired Light Engine and optional Optical Accessory (if needed) is required for each lamp position. Lamp Modules can be inter-mixed within the same housing and are independently controllable.



LAMP MODULE	OPTICAL OPTIONS	OPTICAL ACCESSORIES (Optional)
 <p>J25-XX* LED adjustable *LED Options: HI 3000K White LED HI-2† 3000K White LED WD 3000 - 1800K Warm Dim LED WD-2 2800 - 2200K Warm Dim LED † For use with 10° optic only</p>	<p>10* 10° Very Narrow Spot 15 15° Narrow Spot 25 25° Narrow Flood 40 40° Flood *For use with HI-2 LED only</p>	<p>NSP Narrow Softening Lens NFL Medium Softening Lens FL Wide Softening Lens WFL Extra Wide Softening Lens LS Linear Spread Lens CF24 2400°K Color Filtering Lens CF27 2700°K Color Filtering Lens CF35 3500°K Color Filtering Lens</p>
 <p>K25-XX* LED fixed position *LED Options: HI 3000K White LED HI-2† 3000K White LED WD 3000 - 1800K Warm Dim LED WD-2 2800 - 2200K Warm Dim LED † For use with 10° optic only</p>	<p>10* 10° Very Narrow Spot 15 15° Narrow Spot 25 25° Narrow Flood 40 40° Flood *For use with HI-2 LED only</p>	<p>NSP Narrow Softening Lens NFL Medium Softening Lens FL Wide Softening Lens WFL Extra Wide Softening Lens LS Linear Spread Lens CF24 2400°K Color Filtering Lens CF27 2700°K Color Filtering Lens CF35 3500°K Color Filtering Lens</p>

Optic Option and Accessory Notes

One field interchangeable optic option included standard. Up to two additional optical accessories can be accommodated.

Installation Notes

Ambient temperatures in ceiling space should not exceed 40°C (104°F) during normal operation. For models with **EL1-8**, **EL2-8**, **LU1-8** or **LU2-8** dimming options, ambient temperatures should not exceed 25°C (77°F).

Warranty

All No. 8 Lighting products are by a 5-year limited warranty. For specific warranty details and limitations, see 8lighting.com/resources-downloads

JA8-2019 CA Title 24 Compliant except with dimming option **EL2-8**.

OPTICAL OPTIONS AND ACCESSORY PERFORMANCE SUMMARY

OPTICAL OPTIONS	BEAM ENHANCING LENS (OPTIONAL)*				
	+ NSP	+ NFL	+ FL	+ WFL	+ LS
10° Very Narrow Spot	14°	27°	46°	71°	14 x 52°
15° Spot	20°	27°	42°	61°	19 x 47°
25° Narrow Flood	27°	34°	47°	67°	26 x 52°
40° Flood	41°	42°	56°	68°	36 x 57°
Lumen Multiplier	0.93	0.87	0.88	0.82	0.89

*Beam enhancing lens used in combination with 10°, 15°, 25°, or 40° optic to achieve desired beam spread

LAMP MODULE AND LED PERFORMANCE SUMMARY

Lamp Module	LED	Output	CCT	CRI	Delivered Lumens	System Wattage	Delivered LPW	R1	R2	R3	R4	R5	R6	R7	R8	R9	R10	R11	R12	R13	R14
J2S	HI-2	700	3000	93+	789-803	9.7	81-83	94	97	99	94	94	96	92	83	63	92	95	83	95	99
	HI-2	1000	3000	93+	1009-1023	14.0	72-73	94	97	99	94	94	96	92	83	63	92	95	83	95	99
	HI	700	3000	92+	470-660	9.5	50-70	94	97	99	94	93	97	93	82	60	92	96	83	95	99
	HI	1000	3000	92+	715-950	15.0	48-63	93	97	99	93	93	97	91	81	57	92	94	85	94	99
	WD	1000-WD	3000-1800	97+	603-881	14.3	42-62	99	99	96	99	99	97	98	96	91	97	97	82	100	97
	WD-2	1000-WD	2800-2200	95+	585-855	14.3	41-60	98	97	96	96	99	93	90	86	74	96	96	87	99	99
K2S	HI-2	700	3000	93+	809-821	9.7	83-84	94	97	98	94	94	96	93	84	83	91	95	82	95	98
	HI-2	1000	3000	93+	1077-1087	14.2	76	94	97	98	94	94	96	93	84	83	91	95	82	95	98
	HI	700	3000	92+	550-689	9.3	59-74	94	97	99	94	94	97	92	83	61	92	96	83	95	99
	HI	1000	3000	92+	840-1050	15	56-70	93	97	99	93	93	97	91	81	57	92	94	85	94	99
	WD	1000-WD	3000-1800	97+	703-905	14.5	46-62	99	99	96	99	99	97	98	96	91	96	97	83	100	97
	WD-2	1000-WD	2800-2200	95+	682-878	14.5	47-61	98	97	96	96	99	93	90	86	74	96	96	87	99	99

Note: Performance data shown for individual lamps.

J2S CONE OF LIGHT DIAGRAMS

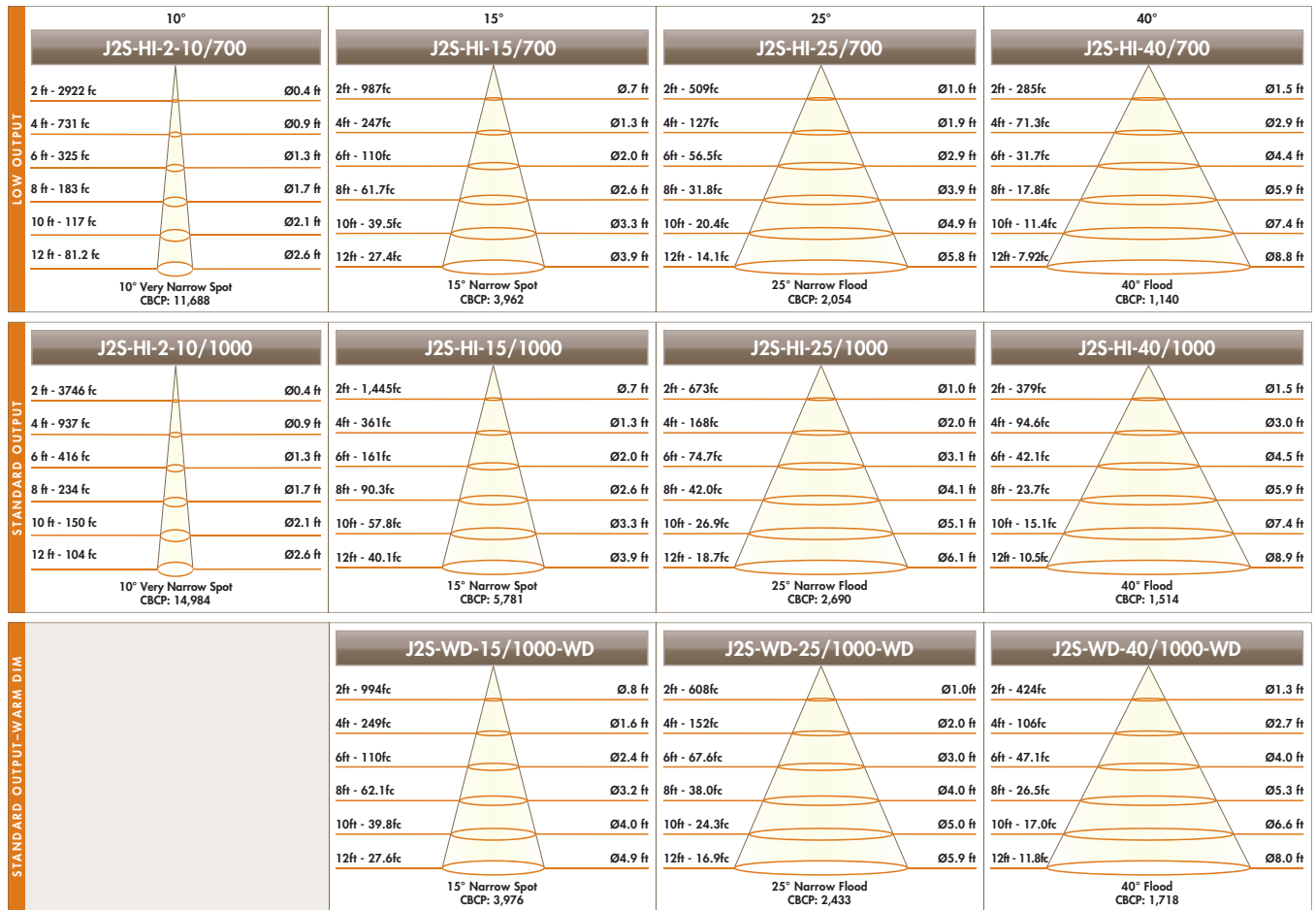

K2S CONE OF LIGHT DIAGRAMS

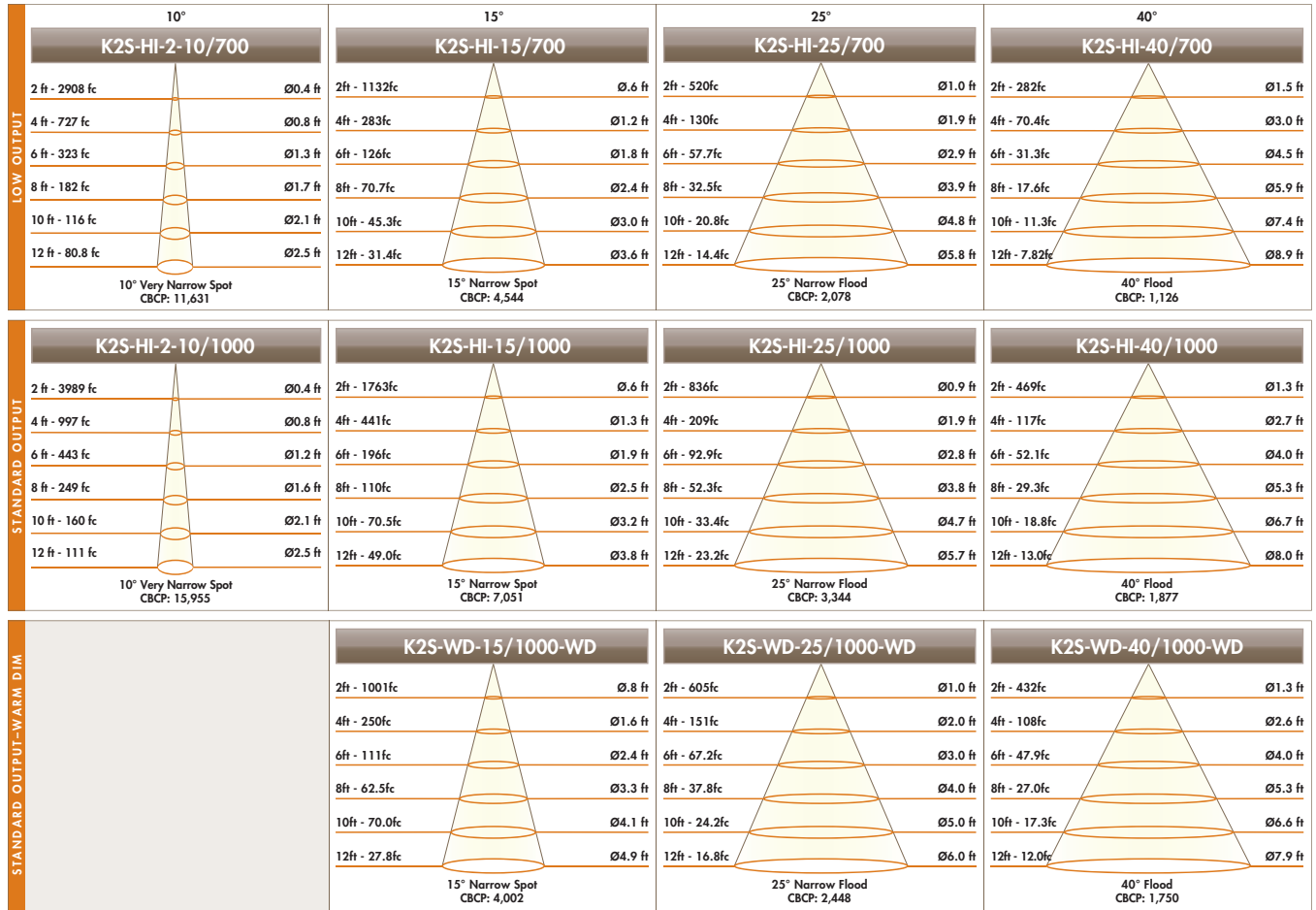

804S/J2S-HI-40 w/ WW-8 WALL WASH ACCESSORY – PERFORMANCE SUMMARY

TRIM	Output	CCT	CRI	Delivered Lumens	System Wattage	Delivered LPW	R1	R2	R3	R4	R5	R6	R7	R8	R9	R10	R11	R12	R13	R14
FS/FLS	1000	3000	92+	591	14.3	41	92.7	96.7	99.5	92.8	92.6	96.7	91.6	80.3	56.5	91.6	94.2	84.0	93.9	99.2
FR/FLR	1000	3000	92+	543	14.3	38	92.3	96.7	99.2	92.1	92.1	96.6	91.0	79.4	54.7	91.6	93.3	83.7	93.6	99.4

LED Lumen Multipliers: For HI-2 LED with 10° optic and FL lens, use multiplier of 1.02. For WD LED with 40° optic, use multiplier of 0.93. For WD-2 LED with 40° optic, use multiplier of 0.90.

804S/J2S-HI-40/1000 w/ FS/FLS TRIM + WW-8 WALL WASH ACCESSORY – FOOTCANDLES ON WALL

FIXTURE DISTANCE TO WALL		24"						30"					
FIXTURE CENTERS (SPACING)		24"			30"			30"			36"		
DISTANCE FROM CEILING	1'	12.6	13.4	12.6	11.7	10.3	11.7	4.4	4.3	4.4	4.1	4.3	4.1
	2'	28.2	31.6	28.2	25.3	27.1	25.3	16.4	17.7	16.4	15.1	15.3	15.1
	3'	21.7	24.1	21.7	19.6	22.1	19.6	17.2	19.3	17.2	15.7	17.5	15.7
	4'	13.6	14.8	13.6	12.6	14.0	12.6	12.7	14.1	12.7	11.8	13.2	11.8
	5'	8.5	9.0	8.5	8.0	8.7	8.0	8.7	9.5	8.7	8.2	9.1	8.2
	6'	5.5	5.7	5.5	5.2	5.5	5.2	6.0	6.4	6.0	5.7	6.1	5.7
	7'	3.7	3.8	3.7	3.5	3.7	3.5	4.2	4.4	4.2	4.0	4.3	4.0
	8'	2.5	2.6	2.5	2.5	2.6	2.5	3.0	3.1	3.0	2.9	3.0	2.9
	9'	1.8	1.9	1.8	1.8	1.8	1.8	2.2	2.2	2.2	2.1	2.2	2.1

804S/J2S-HI-40/1000 w/ FR/FLR TRIM + WW-8 WALL WASH ACCESSORY – FOOTCANDLES ON WALL

FIXTURE DISTANCE TO WALL		24"						30"					
FIXTURE CENTERS (SPACING)		24"			30"			30"			36"		
DISTANCE FROM CEILING	1'	10.6	10.7	10.6	10.0	7.9	10.0	3.6	3.0	3.6	3.4	2.4	3.4
	2'	25.9	38.9	25.9	23.3	24.6	23.3	14.8	16.1	14.8	13.6	13.7	13.6
	3'	20.5	22.8	20.5	18.5	20.8	18.5	16.0	17.9	16.0	14.6	16.2	14.6
	4'	13.0	14.1	13.0	12.0	13.3	12.0	12.0	13.4	12.0	11.1	12.5	11.1
	5'	8.1	8.6	8.1	7.6	8.3	7.6	8.3	9.0	8.3	7.8	8.7	7.8
	6'	5.2	5.4	5.2	5.0	5.3	5.0	5.7	6.1	5.7	5.4	5.9	5.4
	7'	3.5	3.6	3.5	3.4	3.5	3.4	4.0	4.2	4.0	3.8	4.1	3.8
	8'	2.4	2.5	2.4	2.3	2.4	2.3	2.8	2.9	2.8	2.7	2.9	2.7
	9'	1.7	1.8	1.7	1.7	1.8	1.7	2.1	2.1	2.1	2.0	2.1	2.0

Note: With HI or WD LED options, use 40° optic and 20° aiming angle for optimal performance. With HI-2 LED option, use 10° optic + FL lens and 20° aiming angle for optimal performance.