

TRIM: FLINS-LG-W - INSET SERIES™

4" TRIM, 2 3/4" APERTURE FOR WOOD/STONE/ACOUSTIC TILE/SHEETROCK CEILING APPLICATIONS

Project Name	
Date	Type
Prepared By	
Comments	
Catalog #	FLINS - LG - W - /



526 Portal Street
Cotati, CA 94931
USA
P 707.794.0888
F 707.795.4379
www.8lighting.com

All No. 8 Lighting 800 Series trims are UL/CSA listed and CE Certified. No. 8 Lighting trims and lamp modules are protected by one or more U.S. Patents. No. 8 Lighting reserves the right to change details of design, materials, and finish.

© 2020 No. 8 Lighting
Doc # 91318-12.0



PRODUCT FEATURES

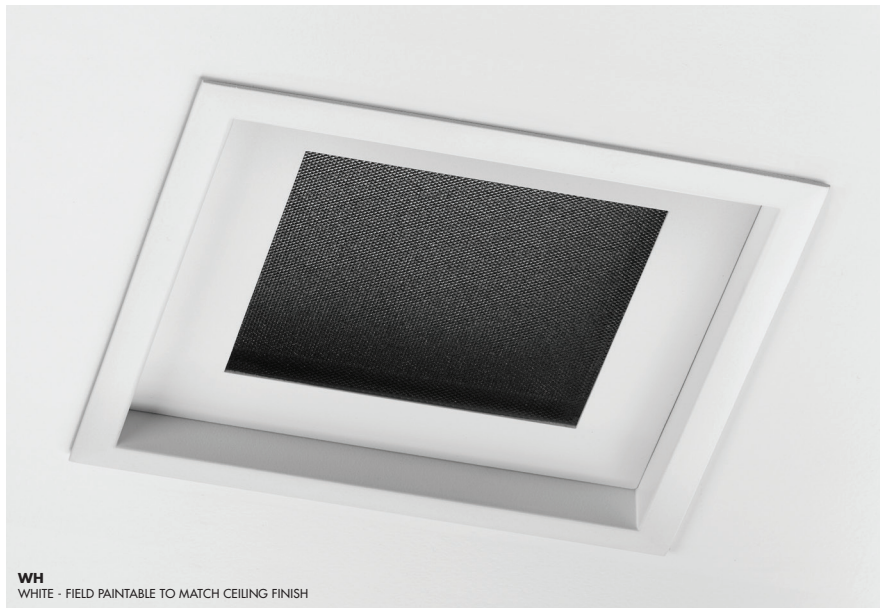

WH
WHITE - FIELD PAINTABLE TO MATCH CEILING FINISH

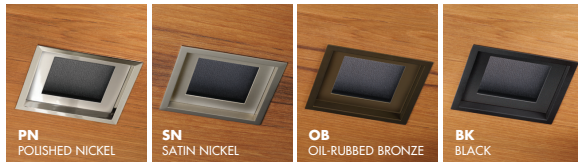

PN
POLISHED NICKEL

SN
SATIN NICKEL

OB
OIL-RUBBED BRONZE

BK
BLACK

Trim Assembly

- **FLINS-LG-W** flanged trim recesses trim plate 1/2" above ceiling surface. Designed for wood, stone, acoustic tile, or sheetrock ceilings.
- Optimized for use with type **A**, **J2/J2S**, and **K2S** lamp modules. Not recommended for use with **B** or **M2/M2S** lamp modules.
- Field adjustable to accommodate ceiling thickness between 1/2" - 1 1/2".
- Die-cast from Zinc alloy for maximum strength, stability, and corrosion resistance.
- 4" trim plate with minimal 2 3/4" aperture.
- Unique magnetic trim plate is removable without marring finishes.
- 4 3/4" wide flanged trim overlaps 4 3/8" ceiling cut out. Height and rotation can be adjusted before or after ceiling installation.
- Features +/- 3° rotational adjustment for squaring trim to other fixtures or nearby walls.
- Works with all Number Eight 800 Series housings.
- Includes Solite soft focus lens standard. Available with other lens options or without lens. **All lens options are factory installed into trim plates and are UL WET LISTED and IP54 Rated for use in DRY, DAMP, or WET locations (covered ceiling applications only). Not for use in steam applications.**
- Available in many designer finishes including: White, Polished Nickel**, Satin Nickel**, Oil-Rubbed Bronze**, and Black**.

****Lot variations in specialty finishes may occur. Ordering ALL trim kits at the same time is recommended to minimize variations in finishes.**

PRODUCT SPECIFIER/PRODUCT ORDER NUMBER

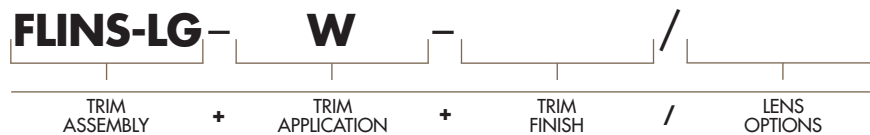
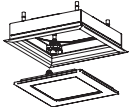
FLINS-LG
Trim INSET 1/2" above finished ceiling
4" SQUARE flangeless w/ 2 3/4" square aperture
Solite soft focus lens installed standard
Note: One-piece die-cast assembly creates 1/2" inset above ceiling.

W
WOOD/STONE/ACOUSTIC TILE/SHEETROCK ceiling applications (1/2" min - 1 1/2" max)

WH
WHITE - Field paintable to match ceiling finish

PN
POLISHED NICKEL*

SN
SATIN NICKEL*

OB
OIL-RUBBED BRONZE*

BK
BLACK*

*Specialty finish. Additional lead time required.

NL
NO LENS installed in trim plate

CL
CLEAR LENS installed in trim plate*

WW
WALL WASH lens installed in trim plate*

*UL Wet listed and IP54 Rated

TRIM ASSEMBLY CROSS SECTION DETAIL

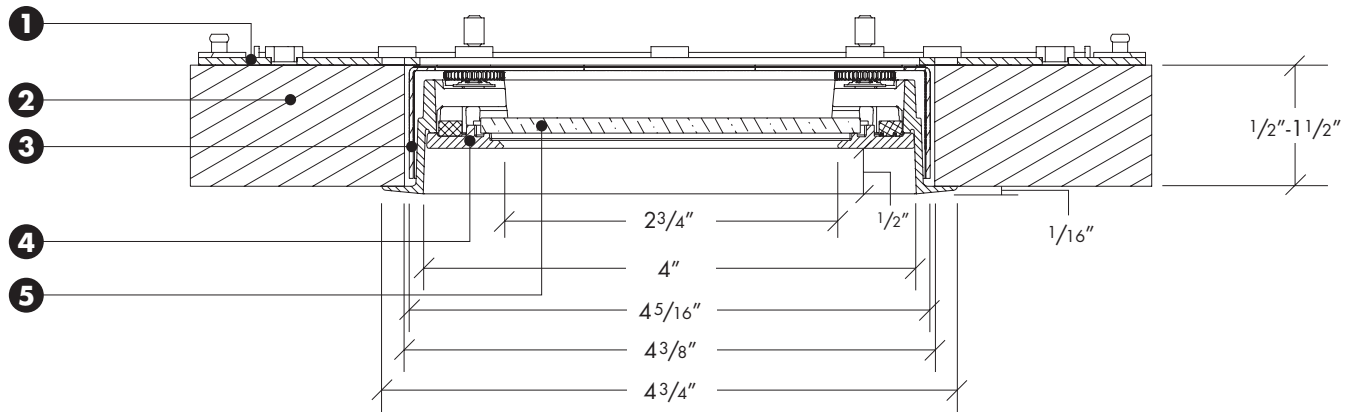

- 1) Housing**
- 2) Wood/Stone Ceiling/Acoustic Tile Material** – Accommodates all thickness from 1/2" to 1 1/2".
- 3) Inset Trim Kit** – 4 3/4" wide flanged trim overlaps 4 3/8" ceiling cut out. Height and rotation can be adjusted before or after ceiling installation.
- 4) Trim Plate** – Features unique magnetic attachments. Mounts 1/2" above finished ceiling.
- 5) Lens** – Factory installed into trim plate. UL WET LISTED and IP54 Rated for use in DRY, DAMP, or WET locations (covered ceiling applications only). Not for use in steam applications.

Note: Cross sections are for illustration purposes only. Refer to W-Series trim installation instructions for complete installation details.