

# TRIM: INS-W - INSET SERIES™

4" TRIM, 1 3/4" APERTURE FOR WOOD/STONE CEILING APPLICATIONS

Project Name	
Date	Type
Prepared By	
Comments	
Catalog #	<b>INS - W -</b> /



**No. 8**  
**eight**  
LIGHTING

526 Portal Street  
Cotati, CA 94931  
USA  
P 707.794.0888  
F 707.795.4379  
www.8lighting.com

All No. 8 Lighting 800 Series trims are UL/CSA listed and CE Certified. No. 8 Lighting trims and lamp modules are protected by one or more U.S. Patents. No. 8 Lighting reserves the right to change details of design, materials, and finish.  
© 2020 No. 8 Lighting  
Doc # 91306-12.0



## PRODUCT FEATURES

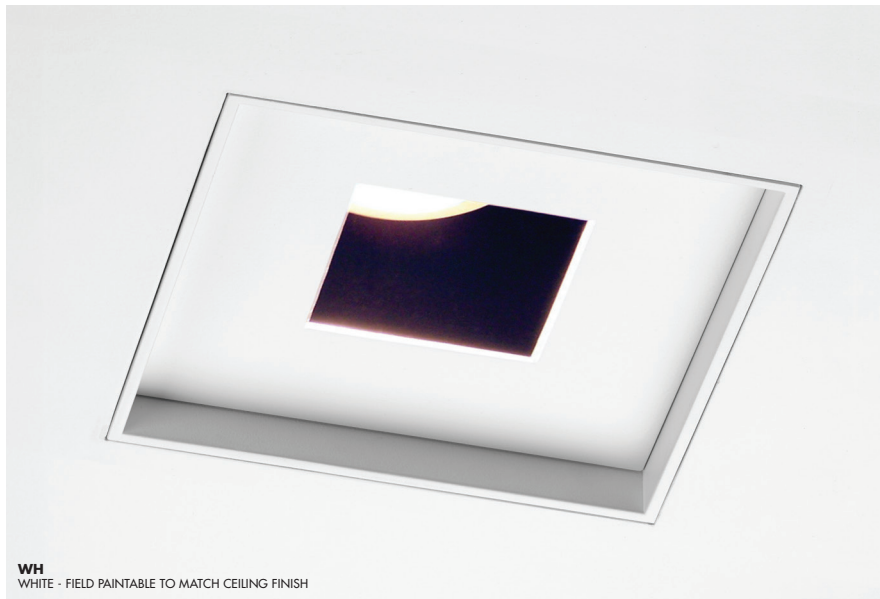

**WH**  
WHITE - FIELD PAINTABLE TO MATCH CEILING FINISH

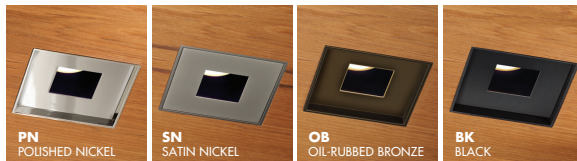

### Trim Assembly

- **INS-W** trim recesses trim plate 1/2" above ceiling surface. Designed for wood/stone ceilings.
- Optimized for use with type **A**, **J2/J2S**, and **K2S** lamp modules. Not recommended for use with **B** or **M2/M2S** lamp modules.
- Trim plate installs 1/2" above the finished ceiling.
- Field adjustable to accommodate ceiling thickness between 1/2" - 1 1/2".
- Die-cast from Zinc alloy for maximum strength, stability, and corrosion resistance.
- 4" trim plate with minimal 1 3/4" aperture.
- Unique magnetic trim plate is removable without marring finishes.
- 4 5/16" wide trim installs flush within 4 3/8" ceiling cut out.
- Features +/- 3° rotational adjustment for squaring trim to other fixtures or nearby walls.
- Can be installed before or after ceiling installation.
- Works with all Number Eight 800 Series housings.
- Available with optional factory installed lenses for harsh environment and beam modification applications. **All lens options are factory installed into trim plates and are UL WET LISTED and IP54 Rated for use in DRY, DAMP, or WET locations (covered ceiling applications only). Not for use in steam applications.**
- Available in many designer finishes including: White, Polished Nickel\*\*, Satin Nickel\*\*, Oil-Rubbed Bronze\*\*, and Black\*\*.

**\*\*Lot variations in specialty finishes may occur. Ordering ALL trim kits at the same time is recommended to minimize variations in finishes.**

## PRODUCT SPECIFIER/PRODUCT ORDER NUMBER

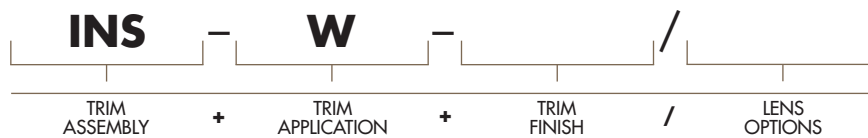
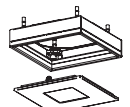
**INS**  
4" SQUARE trim plate w/ 1 3/4" aperture INSET 1/2" above finished ceiling  
4 5/16" flangeless trim installs flush into 4 3/8" ceiling cut out

**W**  
WOOD/STONE ceiling applications (1/2" min - 1 1/2" max)

**WH**  
WHITE - Field paintable to match ceiling finish

**PN**  
POLISHED NICKEL\*

**SN**  
SATIN NICKEL\*

**OB**  
OIL-RUBBED BRONZE\*

**BK**  
BLACK\*

\*Specialty finish. Additional lead time required.

**CL**  
CLEAR LENS installed in trim plate\*

**SF**  
SOFT FOCUS LENS installed in trim plate\*

**WW**  
WALL WASH lens installed in trim plate\*

\*UL Wet listed and IP54 Rated

---

## TRIM ASSEMBLY CROSS SECTION DETAIL

---

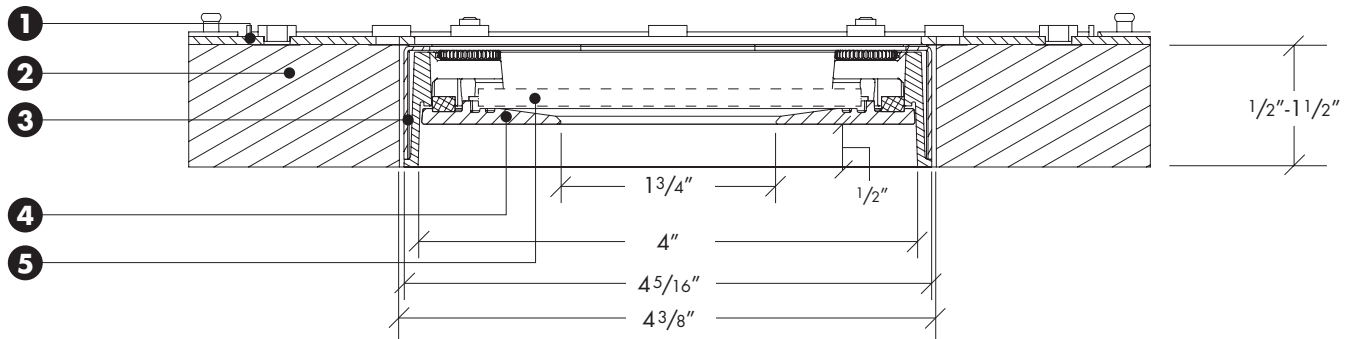

- 1) Housing**
- 2) Wood/Stone Ceiling Material** – Accommodates all thickness from 1/2" to 1 1/2".
- 3) Inset Trim Kit** – 4 5/16" wide trim installs flush within 4 3/8" ceiling cut out. Height and rotation may be adjusted before or after ceiling installation.
- 4) Trim Plate** – Features unique magnetic attachments. Mounts 1/2" above finished ceiling.
- 5) Lens (optional)** – Factory installed into trim plate. UL WET LISTED and IP54 Rated for use in DRY, DAMP, or WET locations (covered ceiling applications only). Not for use in steam applications.

**Note:** Cross sections are for illustration purposes only. Refer to W-Series trim installation instructions for complete installation details.