

**404 NEW CONSTRUCTION IC/AT RATED ADJUSTABLE | MR-16**  
**FLS-4/FLR-4 FLANGED TRIM 2" APERTURE**  
**FRM-4T/FRM-4T-CP MOUNTING FRAME for ACOUSTIC TILE**

Project Name	
Date	Type
Prepared By	
Comments	
Catalog # <b>404 - ET-120 - / - - / -</b>	



**No. 8**  
**eight**  
LIGHTING

526 Portal Street  
Cotati, CA 94931  
USA  
P 707.794.0888  
F 707.795.4379  
www.8lighting.com

All No. 8 Lighting fixtures and components are UL/CSA listed. No. 8 Lighting trims and lamp modules are protected by one or more U.S. Patents. No. 8 Lighting reserves the right to change details of design, materials, and finish.

© 2020 No. 8 Lighting  
Doc # 91293-12.3



**PRODUCT FEATURES**

**Housing + Lamp Module**

- **404** Patented fixture assembly for NEW CONSTRUCTION applications. Two mounting frame options include junction box, power supply, and mounting accessories. Accommodates a wide range of ceiling thicknesses without affecting aiming or adjustment.
- Airtight and IC rated for direct contact with standard or spray-foam\* thermal insulation with a max combined R-value of R42 (may also be installed in Non-IC applications). Meets Washington State Airtight Standard WAC 51-11-0502 and in accordance with ASTM E283 to reduce energy loss. CCEA\* plenum rated for City of Chicago environmental air spaces.
- Fully adjustable MR-16 lamp module features toolless adjustment mechanism optimized for true 0-35° vertical and 360° horizontal adjustment. Use for adjustable accent, wall wash\*\*, and general lighting applications.
- High quality porcelain socket (GX5.3 base) with 14" 18 AWG/250°C PTFE leads.
- 10 watt maximum Halogen or LED MR16 lamp (not included).
- Accepts up to two optical accessories.

\*For spray-foam or CCEA applications, specify **FRM-4T-CP** mounting frame.  
 \*\*For wall washing, use 36-40° beam spread MR-16 and **WW-4** wall wash accessory with trim.

**Transformer**

- **ET-120** Integral electronic transformer. 120v-60Hz input/11.7v output.
- Thermally protected to prevent overheating from mis-lamping.
- Transformer removable and accessible from below after installation.
- For dimmer compatibility testing with SORAA Vivid or Brilliant Series 7.5W LED MR-16 lamps, see: [8lighting.com/resources-downloads/](http://8lighting.com/resources-downloads/)

**Trim Options**

- **FLS-4** Flanged FLAT Square 2" Aperture.
- **FLR-4** Flanged FLAT Round 2" Aperture.
- **FLS-4-BV** Flanged BEVELED Square 2" Aperture.
- **FLR-4-BV** Flanged BEVELED Round 2" Aperture.

**Trim Finish**

- Available finishes include: **WH** - White (field paintable to match ceiling finish) and **OB** - Oil-Rubbed Bronze.

**Trim Accessories**

- **CL4** CLEAR lens factory installed in trim plate.
- **SF4** SOFT FOCUS lens factory installed in trim plate.
- **WW-4** WALL WASH accessory factory installed in trim plate.

**Mounting Frame Options and Accessories**

- **FRM-4T** MOUNTING FRAME for installation in non-supportive (acoustic tile or fabric) ceiling applications with FLANGED trim.
- **FRM-4T-CP** MOUNTING FRAME for installation in non-supportive (acoustic tile or fabric) ceiling applications with FLANGED trim. CCEA approved for Chicago Plenum or spray-foam insulation applications.
- Mounting accessories include: **BH** – Bar Hangers (for joist mounting), **BB** – Butterfly Brackets (for use with commercial c-channel or bar mounting), **TBC-BH** – T-BAR Mounting Clips + Bar Hangers (for T-Bar mounting), or **PMB** – Panel Mounting Brackets (for direct mounting to wood panels).

**JA8-2019 CA Title 24 Compliant** when used with JA8 compliant LED MR-16 lamp.



**404**  
HOUSING +  
LAMP MODULE

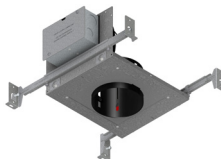

**FRM-4T**  
MOUNTING FRAME +  
POWER SUPPLY



**FLS-4-WH**  
WHITE  
SQUARE FLAT TRIM



**FLS-4-OB**  
OIL-RUBBED BRONZE  
SQUARE FLAT TRIM



**FLR-4-WH**  
WHITE  
ROUND FLAT TRIM



**FLR-4-OB**  
OIL-RUBBED BRONZE  
ROUND FLAT TRIM



**FLS-4-BV-WH**  
WHITE  
SQUARE BEVELED TRIM

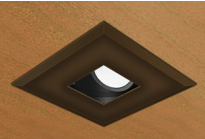

**FLS-4-BV-OB**  
OIL-RUBBED BRONZE  
SQUARE BEVELED TRIM



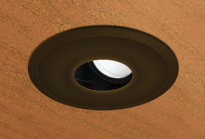

**FLR-4-BV-WH**  
WHITE  
ROUND BEVELED TRIM



**FLR-4-BV-OB**  
OIL-RUBBED BRONZE  
ROUND BEVELED TRIM

PRODUCT SPECIFIER/PRODUCT ORDER NUMBER

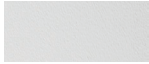
**404** - **ET-120** - /

HOUSING + LAMP MODULE	TRANSFORMER	OPTICAL ACCESSORIES / (Optional)	TRIM OPTIONS	TRIM FINISH	TRIM ACCESSORIES / (Optional)	MOUNTING FRAME OPTIONS	MOUNTING ACCESSORIES
<b>404</b> Housing + Lamp Module for NEW CONSTRUCTION applications AIRTIGHT and IC rated Adjustable MR-16 (10W Max) with 0-35° tilt and 360° rotation	<b>ET-120</b> Integral electronic transformer	<b>SF</b> SOFT FOCUS Lens <b>LS</b> LINEAR SPREAD Lens <b>LSF</b> FROSTED LINEAR SPREAD Lens	<b>FLS-4</b> Flanged FLAT Square 2" Aperture <b>FLR-4</b> Flanged FLAT Round 2" Aperture <b>FLS-4-BV</b> Flanged BEVELED Square 2" Aperture <b>FLR-4-BV</b> Flanged BEVELED Round 2" Aperture	 <b>WH</b> White  <b>OB*</b> Oil-Rubbed Bronze *Specialty finish	<b>CL4*</b> CLEAR lens <b>SF4*</b> SOFT FOCUS lens <b>WW-4*</b> WALL WASH accessory *UL Wet listed	<b>FRM-4T</b> MOUNTING FRAME for FLANGED trims in non-supportive ceilings <b>FRM-4T-CP</b> MOUNTING FRAME for FLANGED trims in non-supportive ceilings. Approved for CCEA and spray-foam insulation applications	<b>BH</b> Bar Hangers <b>BB</b> Butterfly Brackets <b>TBC-BH</b> T-Bar Mounting Clips + Bar Hangers <b>PMB</b> Panel Mounting Brackets

**Optical Accessory Notes**

Up to two optical accessories can be accommodated.

**Trim Finish Notes**

White trim finish is field paintable to match ceiling color. Lot variations may occur with specialty finishes. Ordering ALL trim kits at the same time is recommended to minimize finish variations.

**Trim Accessory Notes**

Trim lens accessories are factory installed into trim plates and are UL WET LISTED and rated for use in DRY, DAMP, or WET locations (covered ceiling applications only). Not for use in steam applications.

**Mounting Option Notes**

Mounting frames include power supply, junction box, and mounting accessories.

**Installation Notes**

For installations in direct contact with thermal insulation, ambient temperatures in ceiling space should not exceed 25°C (77°F) during normal operation. For installations where insulation is held back a minimum of 3" from sides and top, ambient temperatures in ceiling space should not exceed 40°C (104°F) during normal operation.

**Warranty**

All No. 8 Lighting products are by a 5 year limited warranty. For specific warranty details and limitations, see [8lighting.com/resources-downloads](http://8lighting.com/resources-downloads)

**404 + FRM-4T/FRM-4T-CP NEW CONSTRUCTION MOUNTING FRAMES with FLS-4 /FLR-4 FLANGED TRIMS**

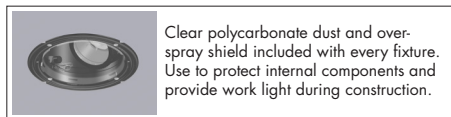
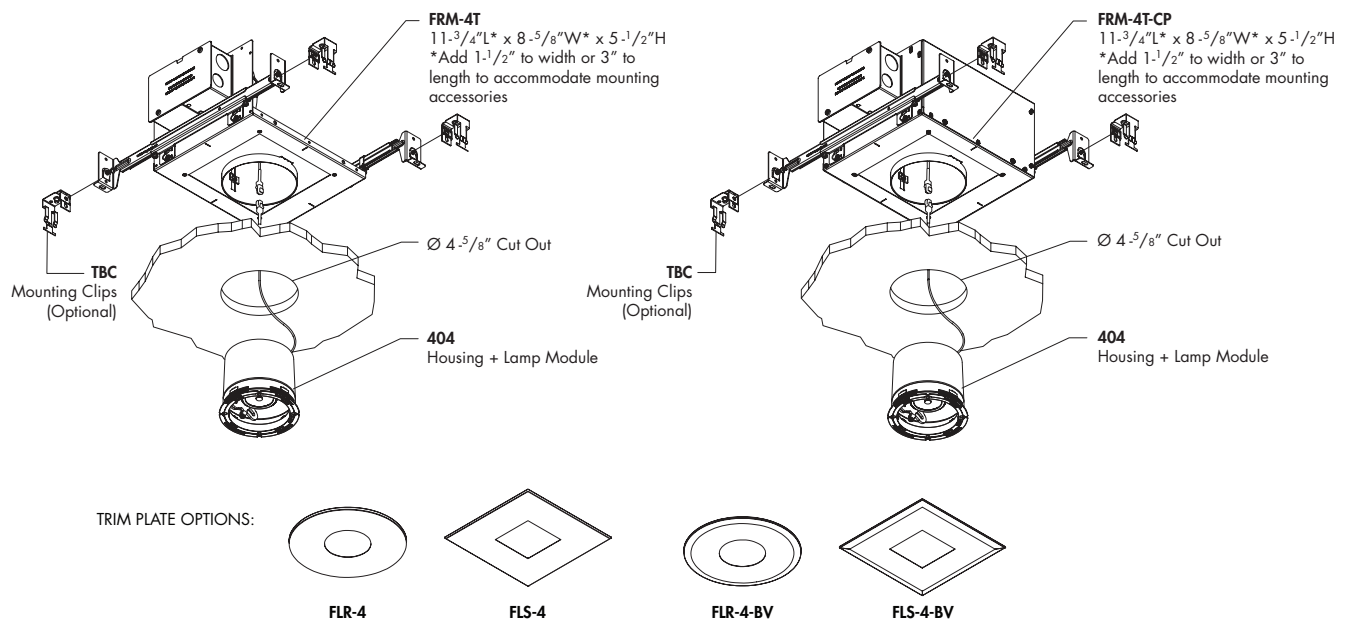

**CEILING TYPES:** Acoustic Tile/Non Supportive | **CEILING THICKNESS:** 1/2" Min to 2" Max | **CUT-OUT:** Ø 4-5/8"

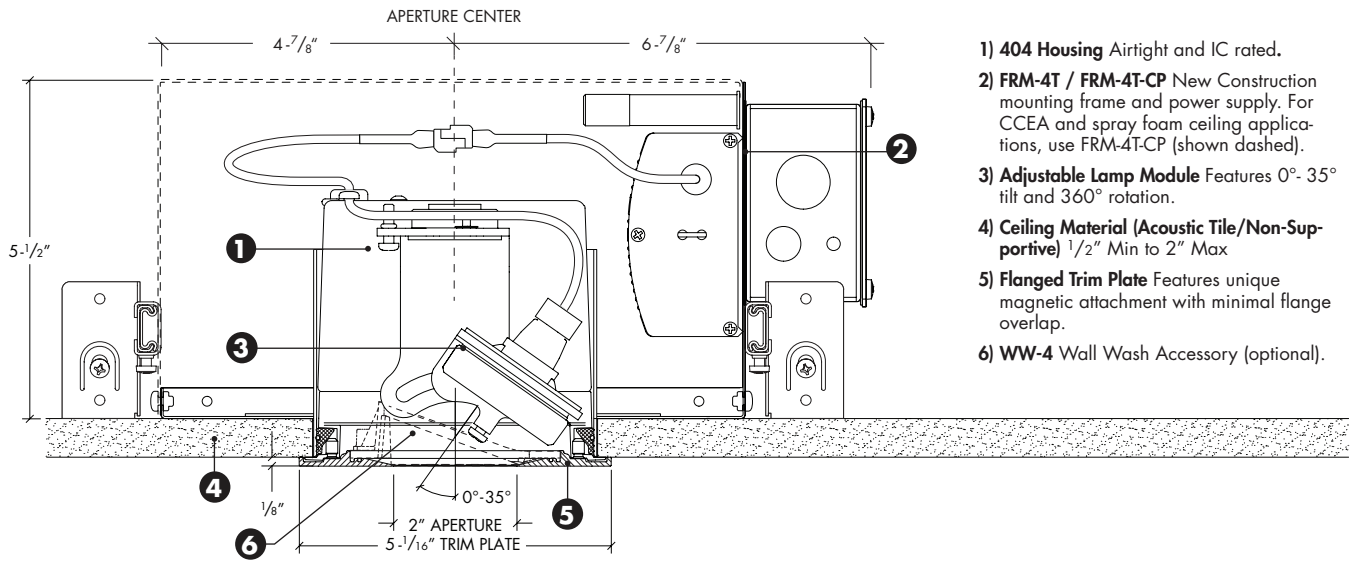

- 1) **404 Housing** Airtight and IC rated.
- 2) **FRM-4T / FRM-4T-CP** New Construction mounting frame and power supply. For CCEA and spray foam ceiling applications, use FRM-4T-CP (shown dashed).
- 3) **Adjustable Lamp Module** Features 0°- 35° tilt and 360° rotation.
- 4) **Ceiling Material (Acoustic Tile/Non-Supportive)** 1/2" Min to 2" Max
- 5) **Flanged Trim Plate** Features unique magnetic attachment with minimal flange overlap.
- 6) **WW-4 Wall Wash Accessory** (optional).