

HOUSING: **804**-I.C. / NON-I.C.
 LAMP MODULE: **H**-WALL WASH | MR-16

| | |
|--------------|-----------------------|
| Project Name | |
| Date | Type |
| Prepared By | |
| Comments | |
| Catalog # | 804 / H- - / - |



526 Portal Street
 Cotati, CA 94931
 USA
 P 707.794.0888
 F 707.795.4379
 www.8lighting.com

All No. 8 Lighting fixtures and components are UL/CSA listed. U.S. Patents Pending on the Seamless™ and Inset™ Series trims as well as the type A Lamp Module. No. 8 Lighting reserves the right to change details of design, materials, and finish.

© 2019 No. 8 Lighting
Doc # 91137-12.0



PRODUCT FEATURES

Housing

- **804** IC-Rated for direct contact with standard or spray-foam thermal insulation with a max combined R-Value of R49 (may also be installed in Non-IC applications).
- Meets Washington State Airtight Standard WAC 51-11-0502 and in accordance with ASTM E283 to reduce energy loss. CCEA plenum rated for City of Chicago environmental air spaces.
- Accepts all Number Eight Lighting **800 Series** MR-16 Lamp Modules and Trim Assemblies.
- Includes bar hangers (for joist mounting) standard.

Lamp Module

- **H** MR-16 wall wash lamp module with integral 4" SQUARE or ROUND trim plate and 1.75" aperture fits into all **800 Series** Seamless trim assemblies.
- Easily removed for servicing or to be interchanged with other Number Eight Lighting lamp modules.
- 50 watt maximum when installed in Non I.C. applications. 35 watt maximum when installed in I.C. applications.
- Includes factory installed wall wash lens.
- UL listed for use in dry, damp, or wet locations (covered ceiling applications only). Not for use in steam applications.

Transformer

- **QT-120** Integral Q-Tran™ toroidal transformer with choke (rated max. 19db). Features dual-tap primary inputs for 100% light output when used with a switched or dimmed circuit. 120v-60Hz input/12v output.
- **ET-120** Integral electronic transformer. 120v-60Hz input/11.7v output.
- High quality porcelain socket (GX5.3 base) with 14" 18 AWG/250°C PTFE leads. Thermally protected to prevent overheating from mis-lamping.
- Transformer removable and accessible from below after installation.

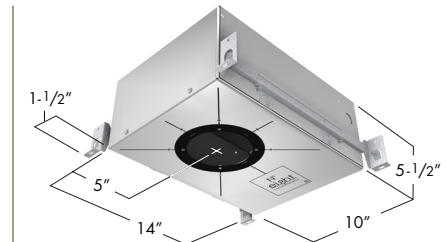

804 - I.C. / NON I.C. HOUSING

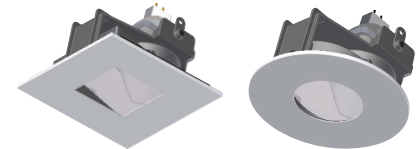

H - MR-16 WALL WASH
 Use for uniformly washing walls. Features minimal 1.75" square or round aperture.

Warranty All No. 8 Lighting products are warranted for five years.

PRODUCT SPECIFIER/PRODUCT ORDER NUMBER

| | | | | | | | | |
|------------|---|--------------------------------|---|-------------|---|-------------|---|--------------------|
| 804 | / | H- | - | | / | | - | |
| HOUSING | / | LAMP MODULE TRIM ASSEMBLY TYPE | - | TRANSFORMER | / | TRIM FINISH | - | ADDITIONAL OPTIONS |

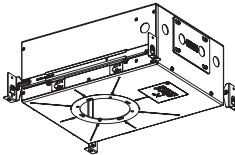

804
 New Construction – AIRTIGHT-I.C./Non-I.C.
 10"W* x 14"L* x 5 1/2"H
 Accepts All No. 8 Lighting MR-16 Lamp Modules
 Rated for direct contact with insulation
 *Add 1 1/2" to length or 3" to width to accommodate bar hangers

MR-16 wall wash
 12 volt/50 watt maximum*

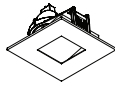

H-S
 4" SQUARE trim plate fits into Seamless Series™ or Inset Series™ trim assemblies



H-R
 4" ROUND trim plate fits into Seamless Series™ trim assemblies
 *35 watt maximum when installed in I.C. applications
 Lamp supplied by others

QT-120
 Q-TRAN™
 Integral toroidal magnetic transformer w/ choke (19 db sound rating)

ET-120
 Integral electronic transformer

WH
 WHITE

PN
 POLISHED NICKEL*

SN
 SATIN NICKEL*

OB
 OIL-RUBBED BRONZE*

BK
 BLACK*

*Specialty finish – Additional lead time required

TBC
 T-BAR MOUNTING CLIPS
 (Set of four) included with housing

PMB
 PANEL MOUNTING BRACKETS
 (Set of two) included with housing

LAMP MODULE H – MR-16 WALL WASH

Lamp Module H incorporates the magnetic trim plate into the lamp module assembly, and is available with either a SQUARE trim plate (Seamless Series™ and Inset Series™), or ROUND trim plate (Seamless Series™ only).

Lamp Module H patent pending lens and lamp holder system designed to evenly wash walls. Trim kit assemblies are available for plaster, wood, stone or acoustic tile ceilings.

Lamp Module H is available in many designer finishes: White, Polished Nickel**, Satin Nickel**, Oil-Rubbed Bronze**, and Black**.



WH - WHITE (SQUARE)



WH - WHITE (ROUND)

****Lot variations in specialty finishes may occur. Ordering ALL trim kits and matching H Modules at the same time is recommended to minimize variations in finishes.**

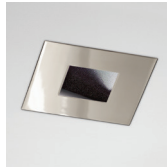

PN
POLISHED NICKEL

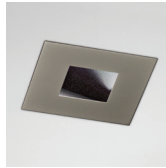

SN
SATIN NICKEL

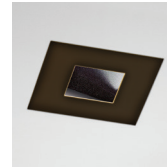

OB
OIL-RUBBED BRONZE

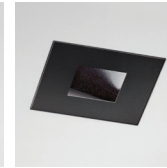

BK
BLACK

LAMP MODULE H – TRIM ASSEMBLY CROSS SECTION DETAIL

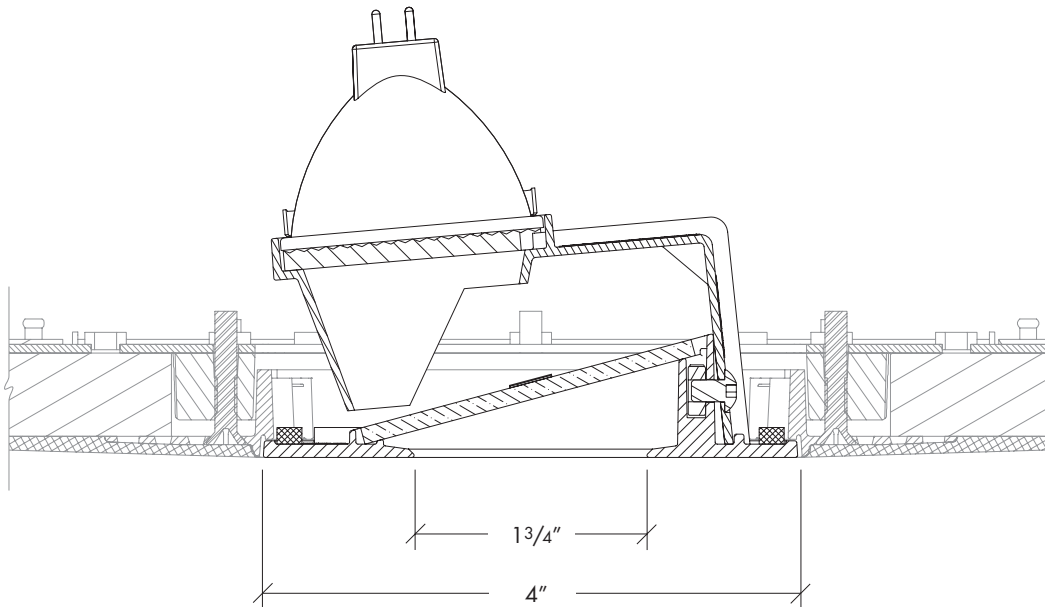

Note: Cross sections are for illustration purposes only. Refer to housing installation instructions for complete installation details.