

HOUSING: **804**-I.C. / NON-I.C.
 LAMP MODULE: **B**-MIRROR REFLECTOR | MR-16

Project Name	
Date	Type
Prepared By	
Comments	
Catalog #	804 / B - - / - -



526 Portal Street
 Cotati, CA 94931
 USA
 P 707.794.0888
 F 707.795.4379
 www.8lighting.com

All No. 8 Lighting fixtures and components are UL/CSA listed. U.S. Patents Pending on the Seamless™ and Inset™ Series trims as well as the type A Lamp Module. No. 8 Lighting reserves the right to change details of design, materials, and finish.

© 2019 No. 8 Lighting
Doc # 91136-12.0



PRODUCT FEATURES

Housing

- **804** IC-Rated for direct contact with standard or spray-foam thermal insulation with a max combined R-Value of R49 (may also be installed in Non-IC applications).
- Meets Washington State Airtight Standard WAC 51-11-0502 and in accordance with ASTM E283 to reduce energy loss. CCEA plenum rated for City of Chicago environmental air spaces.
- Accepts all Number Eight Lighting **800 Series** MR-16 Lamp Modules and Trim Assemblies.
- Includes bar hangers (for joist mounting) standard.

Lamp Module

- **B** MR-16 mirror reflector with integral 4" SQUARE or ROUND trim plate fits into all 800 Series Seamless trim assemblies.
- Ideal for sloped ceiling and certain wall washing applications.
- Features 0-90° vertical adjustment, and 90° horizontal adjustment. Both vertical and horizontal adjustments include tool-free locking to ensure aiming/adjustment remains unaffected during servicing.
- Easily removed for servicing or to be interchanged with other Number Eight Lighting lamp modules.
- 50 watt maximum when installed in Non I.C. applications. 35 watt maximum when installed in I.C. applications.
- Accepts up to one Optical Accessory.

Transformer

- **QT-120** Integral Q-Tran™ toroidal transformer with choke (rated max. 19db). Features dual-tap primary inputs for 100% light output when used with a switched or dimmed circuit. 120v-60Hz input/12v output.
- **ET-120** Integral electronic transformer. 120v-60Hz input/11.7v output.
- High quality porcelain socket (GX5.3 base) with 14" 18 AWG/250°C PTFE leads. Thermally protected to prevent overheating from mis-lamping.
- Transformer removable and accessible from below after installation.

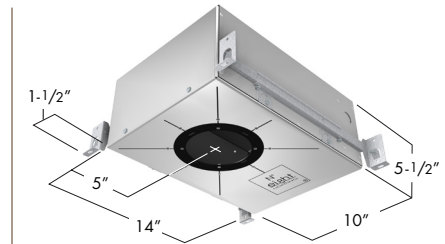

804 - I.C. / NON I.C. HOUSING

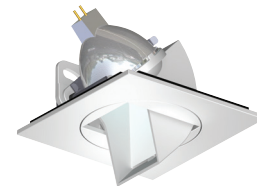



B - MR-16 MIRROR REFLECTOR
 Use on sloped ceilings for general, accent, and wall wash lighting applications. Features 0-90 degree adjustable aiming angle.

Warranty All No. 8 Lighting products are warranted for five years.

PRODUCT SPECIFIER/PRODUCT ORDER NUMBER

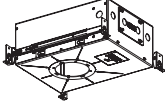
804	/	B	-		/		-		-			
HOUSING	/	LAMP MODULE	-	TRIM ASSEMBLY TYPE	-	TRANSFORMER	/	TRIM FINISH	-	OPTICAL ACCESSORIES	-	ADDITIONAL OPTIONS

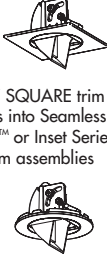
 <p>804 New Construction – AIRTIGHT-I.C./Non-I.C. 10"W* x 14"L* x 5 1/2"H Accepts All No. 8 Lighting MR-16 Lamp Modules Rated for direct contact with insulation *Add 1 1/2" to length or 3" to width to accommodate bar hangers</p>	 <p>B MR-16 mirror reflector 12 volt/50 watt maximum* 90° tilt, 90° rotation with locking vertical and horizontal adjustment Includes clear glass lens *35 watt maximum when installed in I.C. applications Lamp supplied by others</p>	 <p>S 4" SQUARE trim plate fits into Seamless Series™ or Inset Series™ trim assemblies</p> <p>R 4" ROUND trim plate fits into Seamless Series™ trim assemblies</p>	<p>QT-120 Q-TRAN™ Integral toroidal magnetic transformer w/ choke (19db sound rating)</p> <p>ET-120 Integral electronic transformer</p>	<p>WH WHITE (Standard) - Field paintable to match ceiling finish</p> <p>OB OIL-RUBBED BRONZE* *Specialty finish – Additional lead time required</p>	<p>SF SOFT FOCUS lens</p> <p>LS LINEAR SPREAD lens</p> <p>LSF FROSTED LINEAR SPREAD lens</p>	<p>TBC T-BAR MOUNTING CLIPS (Set of four)</p> <p>PMB PANEL MOUNTING BRACKETS (Set of two)</p>
-----------------------------------------------------------------------------------------------------------------------------------------------------------------------------------------------------------------------------------------------------------------------------------------------------------------------------------------------------------------------------------------------------------------------------------------	-----------------------------------------------------------------------------------------------------------------------------------------------------------------------------------------------------------------------------------------------------------------------------------------------------------------------------------------------------------------------------------------------------------------------------------------------------------------	---------------------------------------------------------------------------------------------------------------------------------------------------------------------------------------------------------------------------------------------------------------------------------------------------------------	----------------------------------------------------------------------------------------------------------------------------------------------------------------------------------------------------------------------	----------------------------------------------------------------------------------------------------------------------------------------------------------------------------------------------------------------------------------	----------------------------------------------------------------------------------------------------------------------------------------------------------------------------------	-------------------------------------------------------------------------------------------------------------------------------------------------------

LAMP MODULE B – MR-16 MIRROR REFLECTOR

Lamp Module B incorporates the magnetic trim plate into the lamp module assembly, and is available with either a SQUARE trim plate (Seamless Series™ and Inset Series™), or ROUND trim plate (Seamless Series™ only).

Lamp Module B features 0-90 degree adjustable aiming angle and is designed to work in most slope ceiling environments for general, accent, and wall wash lighting applications. Trim kit assemblies are available for plaster, wood, stone or acoustic tile ceilings.

Lamp Module B is available in two finishes: White and Oil-Rubbed Bronze**.



WH - WHITE (SQUARE) - Field paintable to match ceiling finish



WH - WHITE (ROUND) - Field paintable to match ceiling finish

****Lot variations in specialty finishes may occur. Ordering ALL trim kits and matching B Modules at the same time is recommended to minimize variations in finishes.**



OB-OIL-RUBBED BRONZE

LAMP MODULE B – TRIM ASSEMBLY CROSS SECTION DETAIL

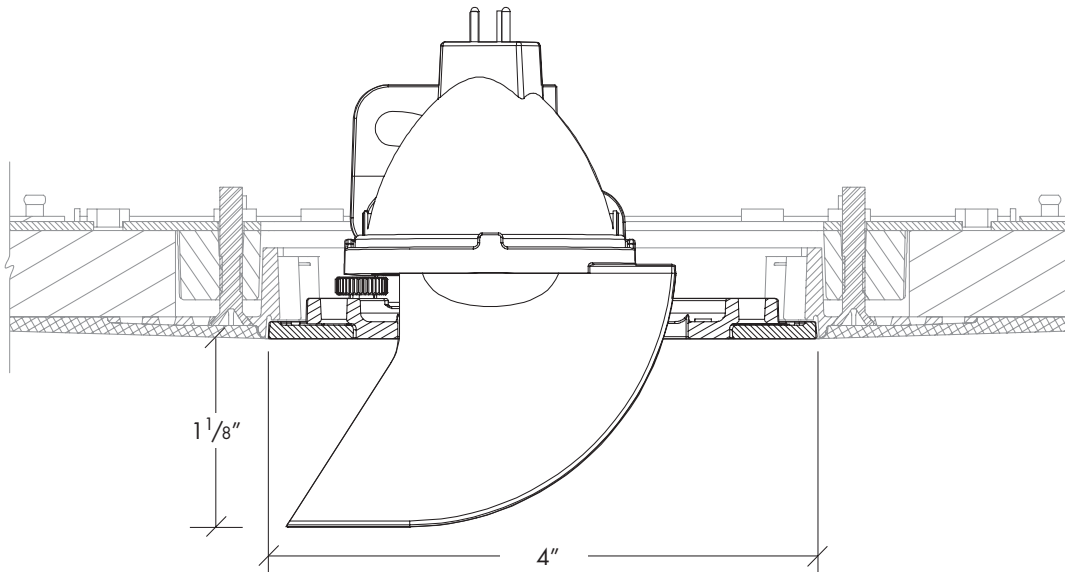

MIRROR REFLECTOR
TILTS FROM
0° TO 90°

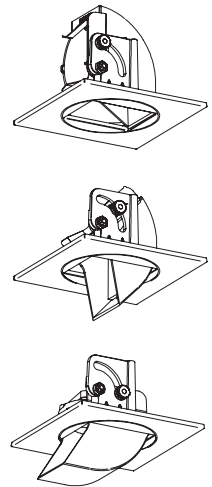

Note: Cross sections are for illustration purposes only. Refer to housing installation instructions for complete installation details.