

404-R REMODEL IC/AT RATED ADJUSTABLE | MR-16 FLS-4/FLR-4 FLANGED TRIM 2" APERTURE

Project Name	
Date	Type
Prepared By	
Comments	
Catalog # 404-R - ET-120 - / - -	



526 Portal Street
Cotati, CA 94931
USA
P 707.794.0888
F 707.795.4379
www.8lighting.com

All No. 8 Lighting fixtures and components are UL/CSA listed. No. 8 Lighting trims and lamp modules are protected by one or more U.S. Patents. No. 8 Lighting reserves the right to change details of design, materials, and finish.

© 2019 No. 8 Lighting
Doc # 91291-12.0



PRODUCT FEATURES

Housing + Lamp Module + Power Supply

- **404-R** Patented fixture assembly for REMODEL applications. Includes INTEGRAL power supply. Accommodates a wide range of ceiling thicknesses without affecting aiming or adjustment.
 - Airtight and IC rated for direct contact with standard thermal insulation with a max combined R-value of R42 (may also be installed in Non-IC applications). Meets Washington State Airtight Standard WAC 51-11-0502 and in accordance with ASTM E283 to reduce energy loss.
 - Fully adjustable MR-16 lamp module features toolless adjustment mechanism optimized for true 0-35° vertical and 360° horizontal adjustment. Use for adjustable accent, wall wash*, and general lighting applications.
 - High quality porcelain socket (GX5.3 base) with 14" 18 AWG/250°C PTFE leads.
 - 10 watt maximum Halogen or LED MR16 lamp (not included).
 - Accepts up to two optical accessories.
 - JA8-2016 CA Title 24 Compliant when used with JA8 Compliant LED MR-16 lamps.
- *For wall washing, use 36-40° beam spread MR-16 and **WW-4** wall wash accessory with trim.

Transformer

- **ET-120** Integral electronic transformer. 120v-60Hz input/11.7v output.
- Thermally protected to prevent overheating from mis-lamping.
- Transformer removable and accessible from below after installation.
- For dimmer compatibility testing with SORAA Vivid or Brilliant Series 7.5W LED MR-16 lamps, see: 8lighting.com/resources-downloads/

Trim Options

- **FLS-4** Flanged FLAT Square 2" Aperture.
- **FLR-4** Flanged FLAT Round 2" Aperture.
- **FLS-4-BV** Flanged BEVELED Square 2" Aperture.
- **FLR-4-BV** Flanged BEVELED Round 2" Aperture.

Trim Finish

- Available finishes include: **WH** - White (field paintable to match ceiling finish) and **OB** - Oil-Rubbed Bronze.

Trim Accessories

- **CL4** CLEAR lens factory installed in trim plate.
 - **SF4** SOFT FOCUS lens factory installed in trim plate.
 - **WW-4** WALL WASH accessory factory installed in trim plate.
- Note: Trim accessories are UL WET LISTED (covered ceiling applications). Not for use in steam applications.

JA8-2016 CA Title 24 Compliant when used with JA8 compliant LED MR-16 lamp.



404-R
HOUSING + LAMP MODULE + POWER SUPPLY

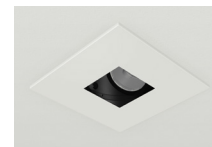

FLS-4-WH
WHITE
SQUARE FLAT TRIM

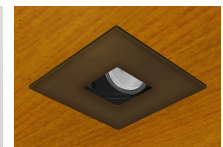

FLS-4-OB
OIL-RUBBED BRONZE
SQUARE FLAT TRIM



FLR-4-WH
WHITE
ROUND FLAT TRIM

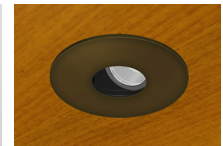

FLR-4-OB
OIL-RUBBED BRONZE
ROUND FLAT TRIM



FLS-4-BV-WH
WHITE
SQUARE BEVELED TRIM

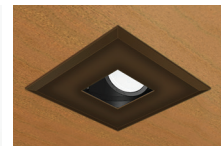

FLS-4-BV-OB
OIL-RUBBED BRONZE
SQUARE BEVELED TRIM



FLR-4-BV-WH
WHITE
ROUND BEVELED TRIM

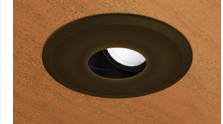

FLR-4-BV-OB
OIL-RUBBED BRONZE
ROUND BEVELED TRIM

PRODUCT SPECIFIER/PRODUCT ORDER NUMBER

404-R - ET-120 - / - - -

HOUSING + LAMP MODULE + POWER SUPPLY - TRANSFORMER - OPTICAL ACCESSORIES (Optional) / TRIM OPTIONS - TRIM FINISH - TRIM ACCESSORIES (Optional)

<p>404-R Housing + Lamp Module + Power Supply for REMODEL applications AIRTIGHT and IC rated Adjustable MR-16 (10W Max) with 0-35° tilt and 360° rotation.</p>	<p>ET-120 Integral electronic transformer</p>	<p>SF SOFT FOCUS Lens LS LINEAR SPREAD Lens LSF FROSTED LINEAR SPREAD Lens</p>	<p>FLS-4 Flanged FLAT Square 2" Aperture FLR-4 Flanged FLAT Round 2" Aperture FLS-4-BV Flanged BEVELED Square 2" Aperture FLR-4-BV Flanged BEVELED Round 2" Aperture</p>	<p>WH White OB Oil-Rubbed Bronze</p>	<p>CL4 CLEAR lens SF4 SOFT FOCUS lens WW-4 WALL WASH accessory Lensed trims and WW-4 accessory are rated for use in DRY, DAMP, or WET locations (covered ceiling applications only).</p>
---	--	---	--	--	---

Up to two optical accessories can be accommodated.

Trim accessories are factory installed into trim plates and are UL WET LISTED (for covered ceiling applications). Wet listed trims are not for use in steam applications.

Warranty All No. 8 Lighting products are warranted for 5 years.

For installations in direct contact with thermal insulation, ambient temperatures in ceiling space should not exceed 25°C (77°F) during normal operation. For installations where insulation is held back a minimum of 3" from sides and top, ambient temperatures in ceiling space should not exceed 40°C (104°F) during normal operation.

404-R FIXTURE ASSEMBLY with FLS-4/FLR-4 FLANGED TRIM - REMODEL MOUNTING

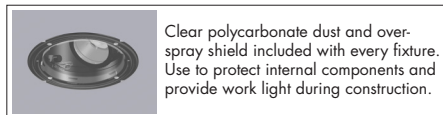
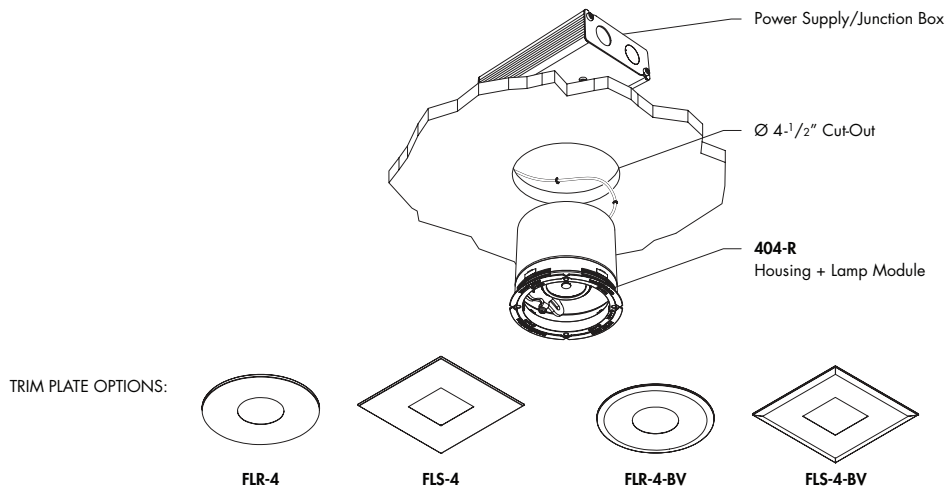

CEILING TYPES: Sheetrock, Wood & Stone | **CEILING THICKNESS:** 1/2" Min to 5-1/2" Max | **CUT-OUT:** Ø 4-1/2"

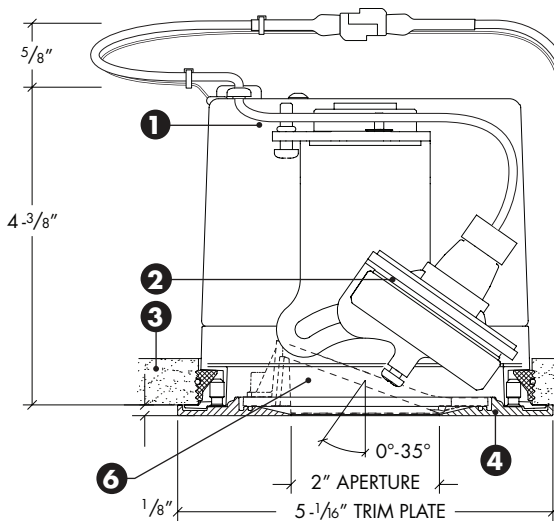

- 1) **400-R REMODEL Housing** Airtight + IC rated. Installs from below finished ceiling.
- 2) **Adjustable Lamp Module** Features 0°- 35° tilt and 360° rotation.
- 3) **Ceiling Material** (sheetrock/wood/stone) Accommodates ceiling thicknesses from 1/2" (min) to 5-1/2" (max) without affecting aiming or rotation. Ceiling material must be rigid and able to support weight of fixture (approximately 5lbs.). Not for use with acoustic tile or non-rigid ceiling materials.
- 4) **Flanged Trim Plate** Features unique magnetic attachment with minimal flange overlap.

- 5) **Power Supply/Junction Box** Installs from below finished ceiling and is accessible after installation. Dimensions: 6-7/16" L x 1-1/2" H x 3-7/8" W.
- 6) **WW-4 Wall Wash Accessory** (optional).