

**400 NEW CONSTRUCTION IC/AT RATED ADJUSTABLE | LED
FLS-4/FLR-4 FLANGED TRIM 2" APERTURE
FRM-4T/FRM-4T-CP MOUNTING FRAME for ACOUSTIC TILE**

Project Name	
Date	Type
Prepared By	
Comments	
Catalog # 400 - - - / - / - - -	



**N^o
eight
LIGHTING**

526 Portal Street
Cotati, CA 94931
USA
P 707.794.0888
F 707.795.4379
www.8lighting.com

All No. 8 Lighting fixtures and components are UL/CSA listed. No. 8 Lighting trims and lamp modules are protected by one or more U.S. Patents. No. 8 Lighting reserves the right to change details of design, materials, and finish.

© 2019 No. 8 Lighting
Doc # 91266-12.2



PRODUCT FEATURES

Housing + Light Engine

- **400** Patented fixture assembly for NEW CONSTRUCTION applications. Two mounting frame options include junction box, power supply, and bar hangers. Accommodates a wide range of ceiling thicknesses without affecting aiming or adjustment.
 - Airtight and IC-Rated for direct contact with standard or spray-foam* thermal insulation with a max combined R-Value of R42 (may also be installed in Non-IC applications). Meets Washington State Airtight Standard WAC 51-1-1-0502 and in accordance with ASTM E283 to reduce energy loss. CCEA* plenum rated for City of Chicago environmental air spaces.
 - Fully adjustable LED lamp module features tool-less adjustment mechanism optimized for true 0-35° vertical and 360° horizontal adjustment. Use for adjustable accent, wall wash**, and general lighting applications.
 - Field interchangeable optic options include: 15°, 25°, and 40°.
- *For spray-foam or CCEA applications, specify **FRM-4T-CP** mounting frame.
For wall washing, specify 40° optic and **WW-4 wall wash accessory with trim.

LED Options

- **H1** 3000K 92+ CRI White LED. Minimum 2-Step color binning.
- **WD** 3000-1800K 97+ CRI Warm Dim LED. Minimum 3-Step color binning.

Optical Accessories (Optional)*

- Field interchangeable beam enhancing lenses** include: **NSP**-Narrow Softening, **NFL**-Medium Softening, **FL**-Wide Softening, **WFL**-Extra Wide Softening, and **LS**-Linear Spread.
- Field interchangeable color filtering lenses include: **CF24**-2400°K, **CF27**-2700°K, & **CF35**-3500°K.

*Up to two optical accessories can be accommodated. ** See Page 3 for details.

Dimming Options

- **DIM1-4** (Standard) Phase dimming LED driver with 120v/60Hz input. Dimmable to 1% using compatible Forward or Reverse-Phase dimmers.
- **DIM2-4** 0-10v dimming LED driver with universal 120-277v/60Hz input. Dimmable to 1% using compatible 0-10v dimmers.
- **PR1-4** Premium phase dimming LED driver with 120v/60Hz input. Dimmable to 0.1% using compatible Forward or Reverse-Phase dimmers.
- **EL1-4** EldoLED 0-10v dimming LED driver with 120-277v/60Hz input. Dimmable to 1% using compatible 0-10v dimmers.
- **EL2-4** EldoLED DALI LED dimming driver with 120-277v/60Hz input. Dimmable to 1% using DALI compatible dimmers.
- **LU1-4** Lutron Hi-lume 1% 2-wire LED driver (120v Forward Phase only). 120v/60Hz input.
- **LU2-4** Lutron Hi-lume 1% EcoSystem LED driver with Softon, Fade-to-Black. 120-277v/60Hz input.
- **LU4-4** Lutron Hi-lume 0.1% EcoSystem LED driver with Soft-on, Fade-to-Black. 120-277v/60Hz input.

For complete list of compatible dimmers, see 8lighting.com/resources-downloads

Output*

- **1000** Standard output. Delivers up to 908 lumens at 14.7 watts
 - **1000-WD** Standard output - Warm Dimming. Delivers up to 834 lumens at 14.6 watts
- *Output may vary depending on optical accessories used.

For photometric files in PDF and IES formats, see 8lighting.com/400-series-photometry

Trim Options

- **FLS-4** Flanged FLAT Square 2" Aperture.
- **FLR-4** Flanged FLAT Round 2" Aperture.
- **FLS-4-BV** Flanged BEVELED Square 2" Aperture.
- **FLR-4-BV** Flanged BEVELED Round 2" Aperture.

Trim Finish

- Available finishes include: **WH** - White (field paintable to match ceiling finish) and **OB** - Oil-Rubbed Bronze.

Trim Accessories

- **CL4** CLEAR lens factory installed in trim plate.
- **SF4** SOFT FOCUS lens factory installed in trim plate.
- **WW-4** WALL WASH accessory factory installed in trim plate.

Note: Trim lens accessories are UL WET LISTED (covered ceiling applications). Not for use in steam applications.

Mounting Options

- **FRM-4T** MOUNTING FRAME for installation in non-supportive (acoustic tile or fabric) ceiling applications with FLANGED trim. Includes power supply, junction box, and bar hangers for joist mounting.
- **FRM-4T-CP** MOUNTING FRAME for installation in non-supportive (acoustic tile or fabric) ceiling applications with FLANGED trim. CCEA approved for Chicago Plenum or spray-foam insulation applications. Includes power supply, junction box, and bar hangers for joist mounting.
- Optional **TBC** T-BAR MOUNTING CLIPS (Set of four) for use with **FRM-4T** or **FRM-4T-CP**.

JAB-2016 CA Title 24 Compliant except with dimming option **EL2-4**.



400
HOUSING +
LIGHT ENGINE

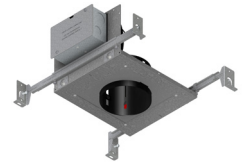

FRM-4T
MOUNTING FRAME +
POWER SUPPLY

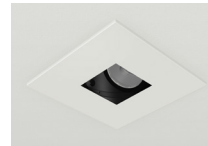

FLS-4-WH
WHITE
SQUARE FLAT TRIM



FLS-4-OB
OIL-RUBBED BRONZE
SQUARE FLAT TRIM



FLR-4-WH
WHITE
ROUND FLAT TRIM



FLR-4-OB
OIL-RUBBED BRONZE
ROUND FLAT TRIM



FLS-4-BV-WH
WHITE
SQUARE BEVELED TRIM

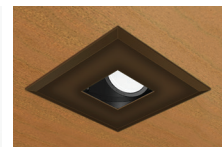

FLS-4-BV-OB
OIL-RUBBED BRONZE
SQUARE BEVELED TRIM



FLR-4-BV-WH
WHITE
ROUND BEVELED TRIM

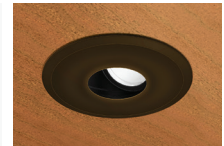

FLR-4-BV-OB
OIL-RUBBED BRONZE
ROUND BEVELED TRIM

PRODUCT SPECIFIER/PRODUCT ORDER NUMBER

400

HOUSING + LIGHT ENGINE + POWER SUPPLY	LED OPTIONS	OPTIC OPTIONS	OPTICAL ACCESSORIES (Optional)	DIMMING OPTIONS	OUTPUT
400 HOUSING + LIGHT ENGINE for New Construction applications. AIRTIGHT and I.C. Rated. 3000K 92+ CRI Adjustable LED with 0-35° Tilt and 360° Rotation.	HI 3000K White LED WD 3000-1800K Warm Dim LED	15 15° Narrow Spot 25 25° Narrow Flood 40 40° Flood	NSP Narrow Softening Lens NFL Medium Softening Lens FL Wide Softening Lens WFL Extra Wide Softening Lens LS Linear Spread Lens CF24 2400°K Color Filtering Lens CF27 2700°K Color Filtering Lens CF35 3500°K Color Filtering Lens	DIM1-4 (Standard) Forward or Reverse-Phase 1% Dimming DIM2-4 0-10v 1% Dimming PR1-4* Forward or Reverse-Phase 0.1% Dimming EL1-4 EldoLED 0-10v 1% Dimming EL2-4 EldoLED DALI 1% Dimming LU1-4 Lutron Forward Phase 1% Dimming LU2-4 Lutron Eco System 1% Dimming LU4-4 Lutron 0.1% EcoSystem Dimming *Not available with WD option	1000 Standard output 1000-WD Standard output – Warm Dimming

TRIM OPTIONS	TRIM FINISH	TRIM ACCESSORIES (Optional)	MOUNTING OPTIONS
FLS-4 Flanged FLAT Square 2" Aperture FLR-4 Flanged FLAT Round 2" Aperture FLS-4-BV Flanged BEVELED Square 2" Aperture FLR-4-BV Flanged BEVELED Round 2" Aperture	WH White OB Oil-Rubbed Bronze	CL4 CLEAR lens SF4 SOFT FOCUS lens WW-4 WALL WASH accessory Lensed trims and WW-4 accessory are rated for use in DRY, DAMP, or WET locations (covered ceiling applications only).	FRM-4T MOUNTING FRAME for FLANGED trims in non-supportive ceilings. FRM-4T-CP MOUNTING FRAME for FLANGED trims in non-supportive ceilings. Approved for CCEA and spray-foam insulation applications. TBC T-BAR MOUNTING CLIPS (set of four) for use with FRM-4T or FRM-4T-CP for T-Bar mounting.

One field interchangeable optic included standard. Up to two additional optical accessories can be accommodated. Bar hangers (for joist mounting) are included standard. Optional mounting accessories shipped separately. Trim lens accessories are factory installed into trim plates and are UL WET LISTED (for covered ceiling applications). Wet listed trims are not for use in steam applications.

Warranty All No. 8 Lighting products are warranted for 5 years.

For installations in direct contact with thermal insulation, ambient temperatures in ceiling space should not exceed 25°C (77°F) during normal operation. For installations where insulation is held back a minimum of 3" from sides and top, ambient temperatures in ceiling space should not exceed 40°C (104°F) during normal operation.

400 + FRM-4T/FRM-4T-CP NEW CONSTRUCTION MOUNTING FRAMES with FLS-4 /FLR-4 FLANGED TRIMS

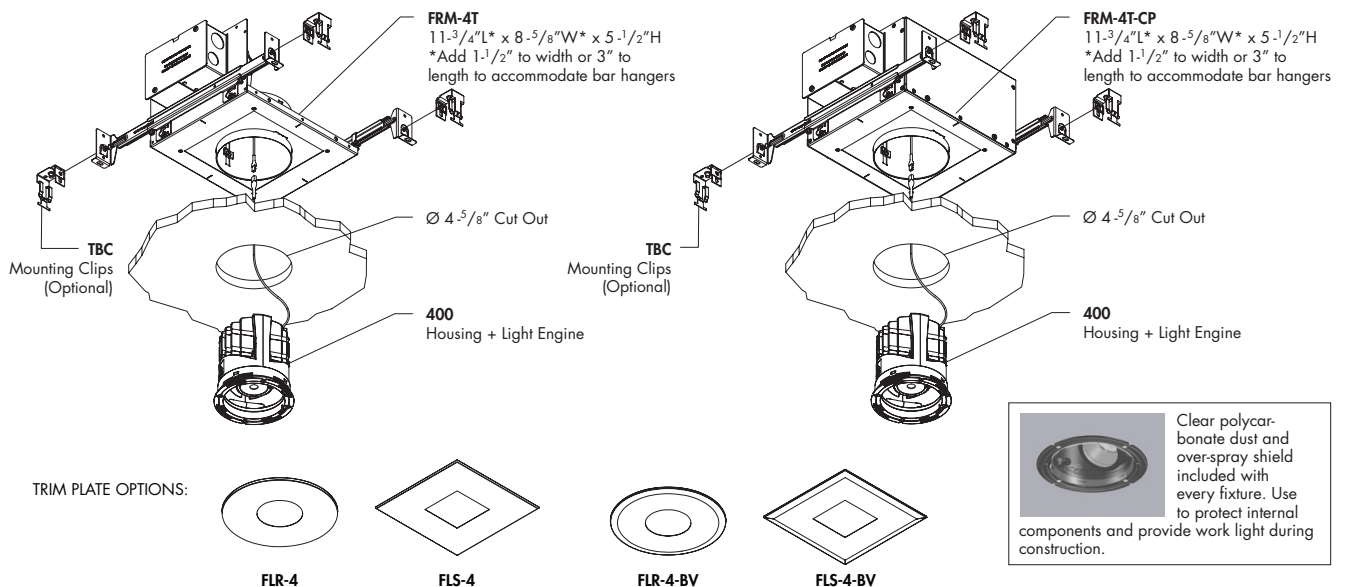

CEILING TYPES: Acoustic Tile/Non Supportive | **CEILING THICKNESS:** 1/2" Min to 5-1/2" Max | **CUT-OUT:** Ø 4-5/8"

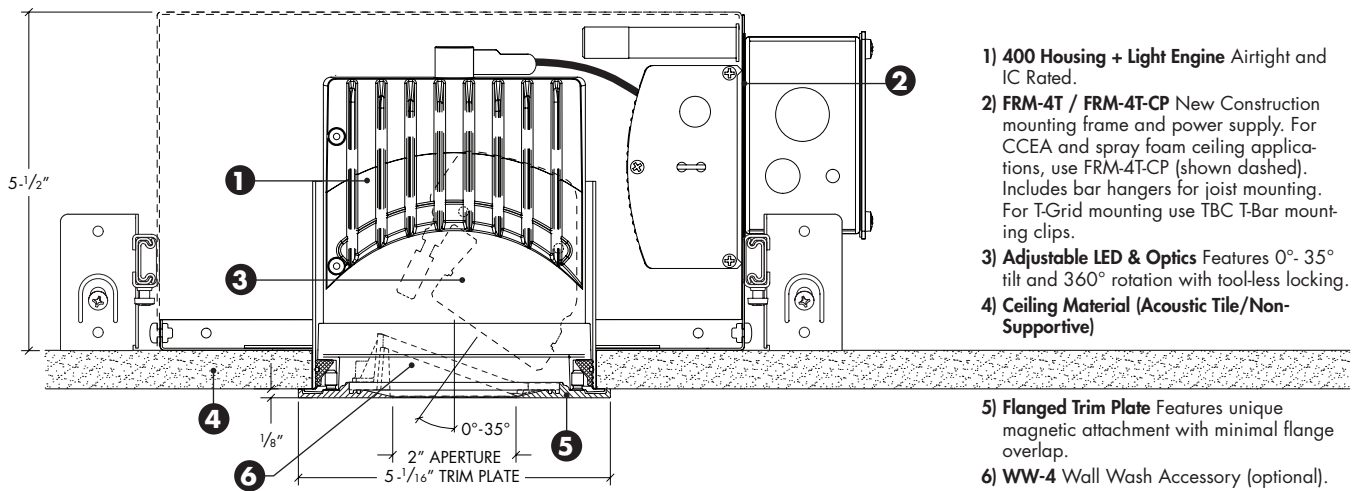

- 1) **400 Housing + Light Engine** Airtight and IC Rated.
- 2) **FRM-4T / FRM-4T-CP** New Construction mounting frame and power supply. For CCEA and spray foam ceiling applications, use FRM-4T-CP (shown dashed). Includes bar hangers for joist mounting. For T-Grid mounting use TBC T-Bar mounting clips.
- 3) **Adjustable LED & Optics** Features 0°- 35° tilt and 360° rotation with tool-less locking.
- 4) **Ceiling Material (Acoustic Tile/Non-Supportive)**
- 5) **Flanged Trim Plate** Features unique magnetic attachment with minimal flange overlap.
- 6) **WW-4** Wall Wash Accessory (optional).

OPTICAL OPTIONS AND ACCESSORY PERFORMANCE SUMMARY

OPTICAL OPTIONS	BEAM ENHANCING LENS (OPTIONAL)*				
	+ NSP	+ NFL	+ FL	+ WFL	+ LS
15° Spot	20°	27°	42°	61°	19 x 47°
25° Narrow Flood	27°	34°	47°	67°	26 x 52°
40° Flood	41°	42°	56°	68°	36 x 57°

*Beam enhancing lens used in combination with 15°, 25°, or 40° optic to achieve desired beam spread

400 SERIES w/ FLS-4/FLR-4 TRIM PERFORMANCE SUMMARY

TRIM	LED	Output	CCT	CRI	Delivered Lumens	System Wattage	Delivered LPW	R1	R2	R3	R4	R5	R6	R7	R8	R9	R10	R11	R12	R13	R14
FLS-4	HI	1000	3000	92+	746-908	14.7	54-62	92.1	95.5	98.2	93.1	91.9	95.2	92.2	80.4	55.4	89.0	94.3	84.4	92.9	98.3
FLR-4	HI	1000	3000	92+	773-897	14.7	53-61	92.1	95.5	98.2	93.1	91.9	95.2	92.2	80.4	55.4	89.0	94.3	84.4	92.9	98.3
FLS-4	WD	1000-WD	3000-1800	97+	689-834	14.6	47-57	99.0	99.3	95.9	98.2	99.4	97.4	98.0	97.2	93.1	96.9	96.1	84.6	99.1	96.6
FLR-4	WD	1000-WD	3000-1800	97+	658-813	14.6	45-55	99.0	99.3	95.9	98.2	99.4	97.4	98.0	97.2	93.1	96.9	96.1	84.6	99.1	96.6

400 SERIES w/ FLS-4/FLR-4 TRIM CONE OF LIGHT DIAGRAMS

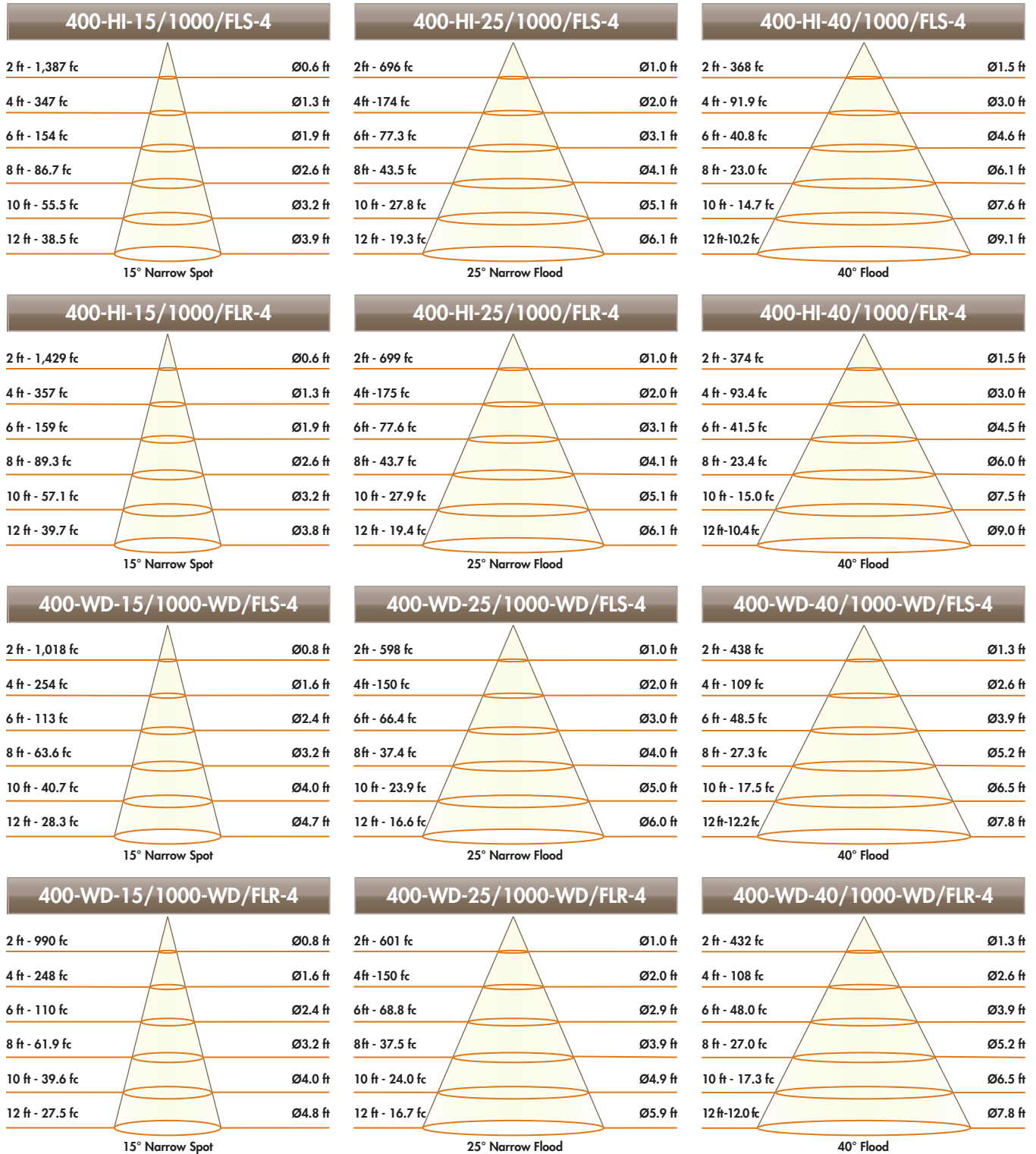

400-HI-40/1000 w/ WW-4 WALL WASH LENS ACCESSORY PERFORMANCE SUMMARY

Trim	Output	CCT	CRI	Delivered Lumens	System Wattage	Delivered LPW	R1	R2	R3	R4	R5	R6	R7	R8	R9	R10	R11	R12	R13	R14
FLS-4	1000	3000	92+	615	14.4	43	92.8	96.6	99.5	92.8	92.5	96.7	91.8	80.6	56.9	91.5	94.1	83.9	93.9	99.1
FLR-4	1000	3000	92+	578	14.4	40	92.8	96.7	99.5	92.7	92.6	96.8	91.6	80.4	56.7	91.7	94.0	84.0	93.9	99.2

Note: For 97+ CRI 3000-1800K "WD" Warm-dimming LED, use multiplier of 0.93.

400-HI-40/1000/FLS-4 TRIM + WW-4 WALL WASH ACCESSORY – FOOTCANDLES ON WALL

FIXTURE DISTANCE TO WALL		24"						30"					
FIXTURE CENTERS (SPACING)		24"			30"			30"			36"		
DISTANCE FROM CEILING	1'	13.4	15.3	13.4	12.1	12.2	12.1	4.2	4.8	4.2	3.9	4.1	3.9
	2'	29.4	33.4	29.4	26.2	29.5	26.2	17.3	19.6	17.3	15.9	17.2	15.9
	3'	21.7	24.0	21.7	19.7	22.3	19.7	17.6	19.8	17.6	16.0	18.3	16.0
	4'	13.3	14.2	13.3	12.3	13.6	12.3	12.6	13.9	12.6	11.7	13.2	11.7
	5'	8.1	8.5	8.1	7.7	8.3	7.7	8.5	9.1	8.5	8.0	8.8	8.0
	6'	5.2	5.4	5.2	5.0	5.2	5.0	5.7	6.0	5.7	5.5	5.9	5.5
	7'	3.4	3.5	3.4	3.3	3.5	3.3	3.9	4.1	3.9	3.8	4.0	3.8
	8'	2.4	2.4	2.4	2.3	2.4	2.3	2.8	2.9	2.8	2.7	2.8	2.7
	9'	1.7	1.7	1.7	1.7	1.7	1.7	2.0	2.1	2.0	2.0	2.1	2.0

400-HI-40/1000/FLR-4 TRIM + WW-4 WALL WASH ACCESSORY – FOOTCANDLES ON WALL

FIXTURE DISTANCE TO WALL		24"						30"					
FIXTURE CENTERS (SPACING)		24"			30"			30"			36"		
DISTANCE FROM CEILING	1'	10.1	10.1	10.1	9.7	7.3	9.7	3.0	2.1	3.0	2.9	1.6	2.9
	2'	27.1	30.4	27.1	24.3	26.1	24.3	15.5	16.9	15.5	14.2	14.5	14.2
	3'	21.1	23.5	21.1	19.0	21.7	19.0	16.7	18.7	16.7	15.2	17.1	15.2
	4'	13.2	14.2	13.2	12.2	13.5	12.2	12.4	13.7	12.4	11.4	12.9	11.4
	5'	8.1	8.5	8.1	7.6	8.3	7.6	8.4	9.1	8.4	7.9	8.7	7.9
	6'	5.2	5.4	5.2	4.9	5.2	4.9	5.7	6.0	5.7	5.4	5.9	5.4
	7'	3.4	3.5	3.4	3.3	3.5	3.3	3.9	4.1	3.9	3.8	4.0	3.8
	8'	2.4	2.4	2.4	2.3	2.4	2.3	2.8	2.9	2.8	2.7	2.8	2.7
	9'	1.7	1.7	1.7	1.7	1.7	1.7	2.0	2.1	2.0	2.0	2.1	2.0

Note: Use 40° flood lens with WW-4 wall wash accessory for optimal performance.