

HOUSING: **804S** – LOW PROFILE LAMP MODULE: **M2S** – MIRROR REFLECTOR | LED

Project Name	
Date	Type
Prepared By	
Comments	
Catalog # 804S/M2S- - - - / / - /	





N^o
eight
LIGHTING

526 Portal Street
Cotati, CA 94931
USA
P 707.794.0888
F 707.795.4379
www.8lighting.com

All No. 8 Lighting fixtures and components are UL/CSA listed. No. 8 Lighting trims and lamp modules are protected by one or more U.S. Patents. No. 8 Lighting reserves the right to change details of design, materials, and finish.

© 2019 No. 8 Lighting
Doc # 91173-11.8

PRODUCT FEATURES

HOUSING

- **804S** Low-Profile universal IC and Non-IC Rated housing available with two output options. Meets Washington State Airtight Standard WAC 51-11-0502 and in accordance with ASTM E283 to reduce energy loss. CCEA plenum rated for City of Chicago environmental air spaces. Low and Standard output options are IC-Rated for direct contact with standard or spray-foam thermal insulation with a max combined R-Value of R42. High output options are Non-IC rated for use where insulation can be kept a minimum of 3" away from all sides.
- Accepts **J2S**, **K2S**, **L2S**, and **M2S** LED Lamp Modules and all **800 Series** Trim Assemblies. Note: Minimum 4-1/2" ceiling space required when used with **INSET** and **BEVEL** Series Trim Assemblies.
- Includes bar hangers (for joist mounting) standard.

Lamp Module

- **M2S** Fully adjustable lamp module features 45-90° vertical and 90° horizontal adjustment. Use on sloped ceilings for adjustable accent, wall wash, and general lighting applications.
- Field interchangeable optic options include: 15°, 25°, and 40°.

LED Options

- **HI** 3000K 92+ CRI White LED. Minimum 2-Step color binning.
- **WD** 3000-1800K 97+ CRI Warm Dim LED. Minimum 3-Step color binning.

Optical Accessories (Optional)*

- Field interchangeable beam enhancing lenses** include: **NSP**-Narrow Softening, **NFL**-Medium Softening, **FL**-Wide Softening, **WFL**-Extra Wide Softening, and **LS**-Linear Spread.
- Field interchangeable color filtering lenses include: **CF24**-2400°K, **CF27**-2700°K, & **CF35**-3500°K.

*Up to two optical accessories can be accommodated.** See Page 2 for details.

Trim Finish Options

- Available finishes include: White and Oil-Rubbed Bronze.

Dimming Options

- **DIM1-8** Phase dimming LED driver with 120v/60Hz input. Dimmable to 1% using compatible Forward or Reverse-Phase dimmers.
- **DIM2-8** 0-10v LED dimming driver with 120-277v/60Hz input. Dimmable to 1% using compatible 0-10v dimmers.
- **PR1-8** Premium phase dimming LED driver with 120v/60Hz input. Dimmable to 0.1% using compatible Forward or Reverse-Phase dimmers.
- **EL1-8** EldoLED 0-10v LED dimming driver with 120-277v/60Hz input. Dimmable to 1% using compatible 0-10v dimmers.
- **EL2-8** EldoLED DALI LED dimming driver with 120-277v/60Hz input. Dimmable to 1% using DALI compatible dimmers.
- **LU1-8** Lutron Hi-lume 1% 2-wire LED driver (120v Forward Phase only). 120v/60Hz input.
- **LU2-8** Lutron Hi-lume 1% EcoSystem LED driver with Soft-on, Fade-to-Black. 120-277v/60Hz input.
- **LU4-8** Lutron Hi-lume 0.1% EcoSystem LED driver with Soft-on, Fade-to-Black. 120-277v/60Hz input.

For a complete list of compatible dimmers, see 8lighting.com/resources-downloads

Output

- **1000** Standard output. Delivers up to 710 lumens at 15 watts.
- **1000-WD** Standard output - Warm Dimming. Delivers up to 570 lumens at 14.8 watts.
- **1400** High output. Delivers up to 940 lumens at 20.7 watts. Available in Type Non-IC only.

For photometric files in PDF and IES formats, see 8lighting.com/800-series-photometry

Mounting Accessories (Optional)

- **TBC** T-Bar mounting clips (set of four)
- **PMB** panel mount brackets (set of two)

For Standard output models, ambient temperatures in ceiling space should not exceed 40°C (104°F) during normal operation. For High Output models and all models with **LU1-8** or **LU2-8** dimming options, ambient temperatures should not exceed 25°C (77°F).

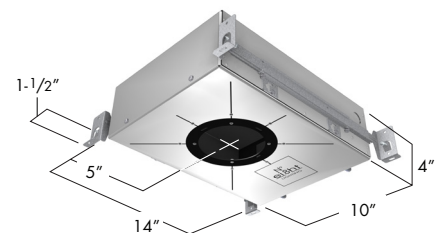



804S - LOW PROFILE HOUSING



M2S-S **M2S-R**
M2S - LED MIRROR REFLECTOR

PRODUCT SPECIFIER/PRODUCT ORDER NUMBER

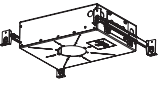
804S / M2S- - - - - - / - - - - - / - - - - - / - - - - -

HOUSING	LAMP MODULE	LED OPTIONS	OPTIC OPTIONS	OPTICAL ACCESSORIES (Optional)	TRIM FINISH	DIMMING OPTIONS	OUTPUT	MOUNTING ACCESSORIES (Optional)
 <p>804S New Construction – Low-Profile AIRTIGHT-IC and Non-IC Rated 10"W* x 14"L* x 4"H *Add 3" to length or width to accommodate bar hangers.</p>	<p>LED MIRROR REFLECTOR</p> <p>M2S-S 4" SQUARE module w/ integral trim plate fits into square Seamless Series™ trim assemblies.</p>  <p>M2S-R 4" ROUND module w/ integral trim plate fits into round Seamless Series™ trim assemblies.</p> 	<p>HI 3000K White LED</p> <p>WD* 3000-1800K Warm Dim LED</p> <p>*Available in standard output only</p>	<p>15 15° Narrow Spot</p> <p>25 25° Narrow Flood</p> <p>40 40° Flood</p>	<p>NSP Narrow Softening Lens</p> <p>NFL Medium Softening Lens</p> <p>FL Wide Softening Lens</p> <p>WFL Extra Wide Softening Lens</p> <p>LS Linear Spread Lens</p> <p>CF24 2400°K Color Filtering Lens</p> <p>CF27 2700°K Color Filtering Lens</p> <p>CF35 3500°K Color Filtering Lens</p>	<p>WH WHITE Field paintable to match ceiling finish</p> <p>OB OIL-RUBBED BRONZE*</p> <p>*Specialty finish. Additional lead time required.</p>	<p>DIM1-8 Forward or Reverse-Phase 1% Dimming</p> <p>DIM2-8 0-10v 1% Dimming</p> <p>PR1-8* Premium Forward or Reverse-Phase 0.1% Dimming</p> <p>EL1-8 EldoLED 0-10v 1% Dimming</p> <p>EL2-8 EldoLED DALI 1% Dimming</p> <p>LU1-8 Lutron Hi-Lume Forward-Phase 1% Dimming</p> <p>LU2-8 Lutron Hi-Lume Eco System 1% Dimming</p> <p>LU4-8 Lutron 0.1% Eco-System Dimming</p> <p>*Not available with WD option</p>	<p>1000 Standard output</p> <p>1000-WD Standard output – Warm Dimming</p> <p>1400* High output</p> <p>*Non-IC only. Not available w/ LU2-8 or LU4-8 dimming options.</p>	<p>TBC T-BAR MOUNTING CLIPS (Set of four)</p> <p>PMB PANEL MOUNTING BRACKETS (Set of two)</p>

One field interchangeable optic option included standard. Up to two additional optical accessories can be accommodated. Bar hangers (for joist mounting) are included standard. Optional mounting accessories shipped separately. **Warranty:** All No. 8 Lighting products are warranted for 5 years.

804S/M2S PERFORMANCE SUMMARY

LED	Output	CCT	CRI	Delivered Lumens	System Wattage	Delivered LPW	R1	R2	R3	R4	R5	R6	R7	R8	R9	R10	R11	R12	R13	R14
HI	1000	3000	92+	596-712	15	39-47	92.3	96.6	99.2	91.9	92.0	96.3	91.2	79.7	55.0	91.4	92.9	82.1	93.5	99.4
WD	1000-WD	3000-1800	97+	474-569	14.8	32-39	99.1	99.0	96.1	98.6	98.1	97.2	97.3	94.9	87.8	95.5	97.5	82.5	99.6	96.8
HI	1400	3000	92+	755-944	20.7	37-46	92.8	98.3	97.0	90.7	92.5	97.3	89.4	79.0	54.7	94.9	91.9	82.1	94.6	99.2

OPTICAL OPTIONS AND ACCESSORY PERFORMANCE SUMMARY

OPTICAL OPTIONS	BEAM ENHANCING LENS (OPTIONAL)*				
	+ NSP	+ NFL	+ FL	+ WFL	+ LS
15° Spot	20°	27°	42°	61°	19 x 47°
25° Narrow Flood	27°	34°	47°	67°	26 x 52°
40° Flood	41°	42°	56°	68°	36 x 57°

*Beam enhancing lens used in combination with 15°, 25°, or 40° optic to achieve desired beam spread

LAMP MODULE M2S – LED MIRROR REFLECTOR

Lamp Module M2S incorporates the magnetic trim plate into the lamp module assembly, and is available with either a SQUARE or ROUND trim plate (Seamless Series™ only).

Lamp Module M2S features 45-90 degree adjustable aiming angle and is designed to work in most slope ceiling environments for general, accent, and wall wash lighting applications. Trim kit assemblies are available for plaster, wood, stone or acoustic tile ceilings.

Lamp Module M2S is available in two finishes: White and Oil-Rubbed Bronze**.

****Lot variations in specialty finishes may occur. Ordering ALL trim kits and matching M2S Modules at the same time is recommended to minimize variations in finishes.**

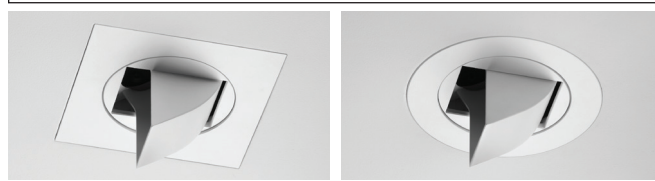

WH - WHITE (SQUARE)
Field paintable to match ceiling finish

WH - WHITE (ROUND)
Field paintable to match ceiling finish

OB
OIL-RUBBED BRONZE

LAMP MODULE M2S – TRIM ASSEMBLY CROSS SECTION DETAIL

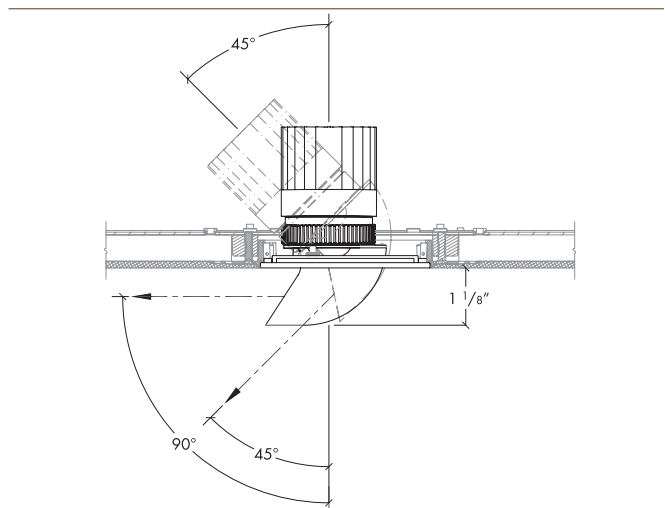

Note: Cross sections are for illustration purposes only. Refer to housing installation instructions for complete installation details.