

HOUSING: **804S** – LOW PROFILE LAMP MODULE: **L2S** – WALL WASH | LED

Project Name	
Date	Type
Prepared By	
Comments	
Catalog # 804S/L2S- - - / / - /	



526 Portal Street
Cotati, CA 94931
USA
P 707.794.0888
F 707.795.4379
www.8lighting.com

All No. 8 Lighting fixtures and components are UL/CSA listed. No. 8 Lighting trims and lamp modules are protected by one or more U.S. Patents. No. 8 Lighting reserves the right to change details of design, materials, and finish.

© 2019 No. 8 Lighting
Doc # 91172-11.8



PRODUCT FEATURES

HOUSING

- **804S** Low-Profile universal IC and Non-IC Rated housing available with two output options. Meets Washington State Airtight Standard WAC 51-11-0502 and in accordance with ASTM E283 to reduce energy loss. CCEA plenum rated for City of Chicago environmental air spaces. Standard output options are IC-Rated for direct contact with standard or spray-foam thermal insulation with a max combined R-Value of R42. High output options are Non-IC rated for use where insulation can be kept a minimum of 3" away from all sides.
- Accepts **J2S**, **K2S**, **L2S**, and **M2S** LED Lamp Modules and all **800 Series** Trim Assemblies. Note: Minimum 4-1/2" ceiling space required when used with INSET and BEVEL Series Trim Assemblies.
- Includes bar hangers (for joist mounting) standard.

Lamp Module

- **L2S** Fixed position wall wash lamp module with integral 4" SQUARE or ROUND trim plate and 1.75" aperture fits into all 800 Series Seamless trim assemblies.
- Includes factory installed wall wash lens and 40° optic.
- UL listed for use in dry, damp, or wet locations (covered ceiling applications only). Not for use in steam applications.

LED Options

- **H1** 3000K 92+ CRI White LED. Minimum 2-Step color binning.
- **WD** 3000-1800K 97+ CRI Warm Dim LED. Minimum 3-Step color binning.

Optical Accessories (Optional)

- Field interchangeable color filtering lenses include: **CF24**-2400°K, **CF27**-2700°K, & **CF35**-3500°K.

Trim Finish Options

- Available in many designer finishes including: White, Polished Nickel, Satin Nickel, Oil-Rubbed Bronze, and Black.

Dimming Options

- **DIM1-8** Phase dimming LED driver with 120v/60Hz input. Dimmable to 1% using compatible Forward or Reverse-Phase dimmers.
- **DIM2-8** 0-10v LED dimming driver with 120-277v/60Hz input. Dimmable to 1% using compatible 0-10v dimmers.
- **PR1-8** Premium phase dimming LED driver with 120v/60Hz input. Dimmable to 0.1% using compatible Forward or Reverse-Phase dimmers.
- **EL1-8** EldoLED 0-10v LED dimming driver with 120-277v/60Hz input. Dimmable to 1% using compatible 0-10v dimmers.
- **EL2-8** EldoLED DALI LED dimming driver with 120-277v/60Hz input. Dimmable to 1% using DALI compatible dimmers.
- **LU1-8** Lutron Hi-lume 1% 2-wire LED driver (120v Forward Phase only). 120v/60Hz input.
- **LU2-8** Lutron Hi-lume 1% EcoSystem LED driver with Soft-on, Fade-to-Black. 120-277v/60Hz input.
- **LU4-8** Lutron Hi-lume 0.1% EcoSystem LED driver with Soft-on, Fade-to-Black. 120-277v/60Hz input.

For a complete list of compatible dimmers, see 8lighting.com/resources-downloads

Output

- **1000** Standard output. Delivers up to 330 lumens at 15 watts.
- **1000-WD** Standard output - Warm Dimming. Delivers up to 350 lumens at 14.7 watts.
- **1400** High output. Delivers up to 570 lumens at 20.7 watts. Available in Type Non-IC only.

For photometric files in PDF and IES formats, see 8lighting.com/800-series-photometry

Mounting Accessories (Optional)

- **TBC** T-Bar mounting clips (set of four)
- **PMB** panel mount brackets (set of two)

For Standard output models, ambient temperatures in ceiling space should not exceed 40°C (104°F) during normal operation. For High Output models and all models with **LU1-8** or **LU2-8** dimming options, ambient temperatures should not exceed 25°C (77°F).

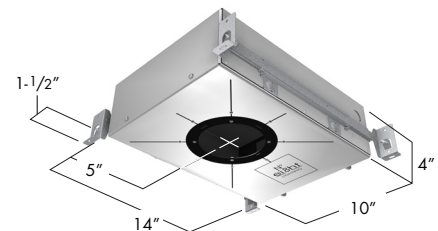

804S - LOW PROFILE HOUSING

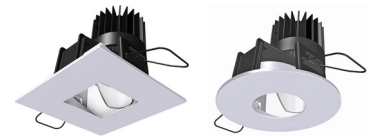

L2S-S **L2S-R**
L2S - LED WALL WASH

PRODUCT SPECIFIER/PRODUCT ORDER NUMBER

804S / L2S-

HOUSING / LAMP MODULE - LED OPTIONS - OPTICAL ACCESSORIES (Optional) / TRIM FINISH / DIMMING OPTIONS - OUTPUT / MOUNTING ACCESSORIES (Optional)

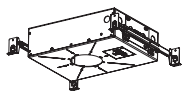

804S
New Construction – Low-Profile AIRTIGHT-IC and Non-IC Rated 10"W* x 14"L* x 4"H
*Add 3" to length or width to accommodate bar hangers

LED WALL WASH

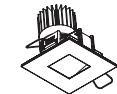

L2S-S
4" SQUARE module w/ integral trim plate fits into square Seamless Series™ trim assemblies



L2S-R
4" ROUND module w/ integral trim plate fits into round Seamless Series™ trim assemblies

HI
3000K White LED
WD*
3000-1800K Warm Dim LED
*Available in standard output only

CF24
2400°K Color Filtering Lens
CF27
2700°K Color Filtering Lens
CF35
3500°K Color Filtering Lens

WH
WHITE (Standard)
Field paintable to match ceiling finish
PN
POLISHED NICKEL*
SN
SATIN NICKEL*
OB
OIL-RUBBED BRONZE*
BK
BLACK*
*Specialty finish Additional lead time required

DIM1-8
Forward or Reverse-Phase 1% Dimming
DIM2-8
0-10v 1% Dimming
PR1-8*
Premium Forward or Reverse-Phase 0.1% Dimming
EL1-8
EldoLED 0-10v 1% Dimming
EL2-8
EldoLED DALI 1% Dimming
LU1-8
Lutron Hi-Lume Forward-Phase 1% Dimming
LU2-8
Lutron Hi-Lume EcoSystem 1% Dimming
LU4-8
Lutron 0.1% EcoSystem Dimming
*Not available with WD option

1000
Standard output
1000-WD
Standard output – Warm Dimming
1400*
High output
*Non-IC only. Not available w/ LU2-8 or LU4-8 dimming options.

TBC
T-BAR MOUNTING CLIPS (Set of four)
PMB
PANEL MOUNTING BRACKETS (Set of two)

One field interchangeable optic option included standard. Up to two additional optical accessories can be accommodated. Bar hangers (for joist mounting) are included standard. Optional mounting accessories shipped separately.
Warranty: All No. 8 Lighting products are warranted for 5 years.

804S/L2S PERFORMANCE SUMMARY

LED	Output	CCT	CRI	Delivered Lumens	System Wattage	Delivered LPW	R1	R2	R3	R4	R5	R6	R7	R8	R9	R10	R11	R12	R13	R14
HI	1000	3000	92+	290-330	15	19-22	92.5	96.8	99.2	92.0	92.2	96.4	91.2	79.9	55.6	91.6	93.1	82.5	93.7	99.4
WD*	1000-WD	3000-1800	97+	293-351	14.7	20-24	99.1	99.3	96.5	98.8	98.8	97.1	97.3	95.9	90.8	97.0	97.1	83.3	99.4	97.0
HI	1400	3000	92+	477-573	20.7	23-28	93.5	99.0	96.2	91.1	93.3	96.9	89.1	79.0	56.6	96.7	92.5	83.4	95.4	98.8

LAMP MODULE L2S – LED WALL WASH

Lamp Module L2S incorporates the magnetic trim plate into the lamp module assembly, and is available with either a SQUARE or ROUND trim plate (Seamless Series™ only).

Lamp Module L2S patent pending lens and lamp holder system designed to evenly wash walls. Trim kit assemblies are available for plaster, wood, stone or acoustic tile ceilings.

Lamp Module L2S is available in many designer finishes: White, Polished Nickel**, Satin Nickel**, Oil-Rubbed Bronze**, and Black**.

****Lot variations in specialty finishes may occur. Ordering ALL trim kits and matching L2S Modules at the same time is recommended to minimize variations in finishes.**

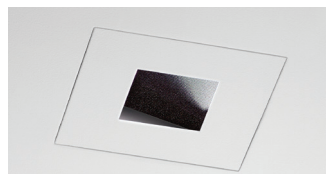

WH - WHITE (SQUARE)



WH - WHITE (ROUND)

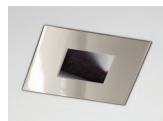

PN POLISHED NICKEL

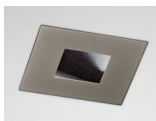

SN SATIN NICKEL

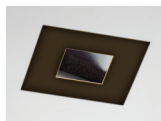

OB OIL-RUBBED BRONZE

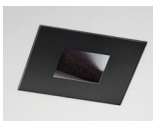

BK BLACK

LAMP MODULE L2S – TRIM ASSEMBLY CROSS SECTION DETAIL

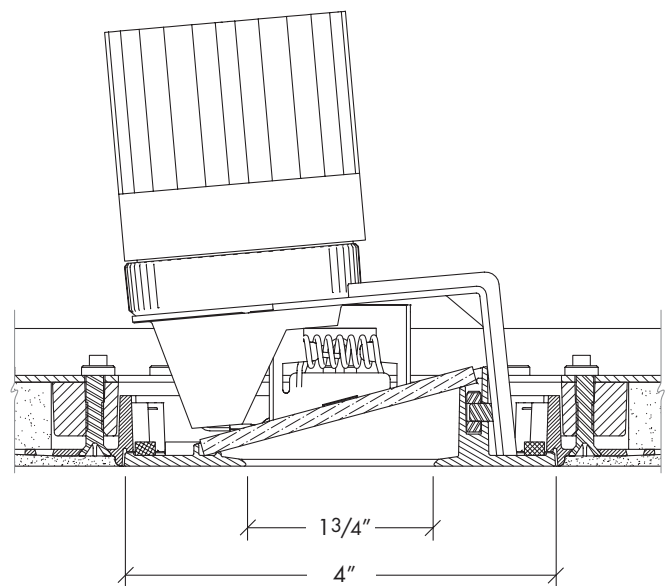

Note: Cross sections are for illustration purposes only. Refer to housing installation instructions for complete installation details.