

TRIM: FLS-LG-W - SEAMLESS SERIES™ / FLANGED SQUARE

4" TRIM, 2 3/4" APERTURE FOR WOOD/STONE/ACOUSTIC TILE/SHEETROCK CEILING APPLICATIONS

Project Name	
Date	Type
Prepared By	
Comments	
Catalog #	FLS - LG - W - /



No. 8
eight
LIGHTING

526 Portal Street
Cotati, CA 94931
USA
P 707.794.0888
F 707.795.4379
www.8lighting.com

All No. 8 Lighting fixtures and components are UL/CSA listed. U.S. Patents Pending on the Seamless™ and Inset™ Series trims as well as the Type A Lamp Module. No. 8 Lighting reserves the right to change details of design, materials, and finish.

© 2017 No. 8 Lighting
Doc # 91316-11.1



PRODUCT FEATURES

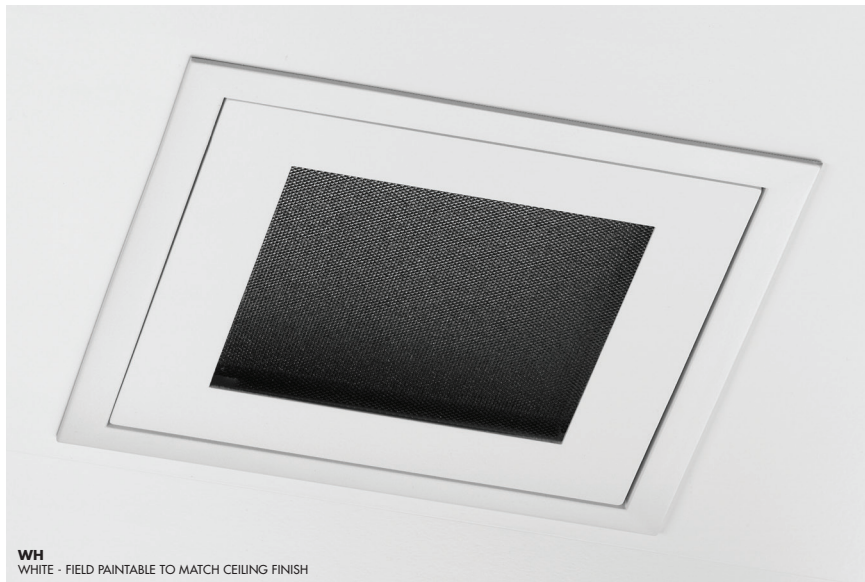

WH
WHITE - FIELD PAINTABLE TO MATCH CEILING FINISH

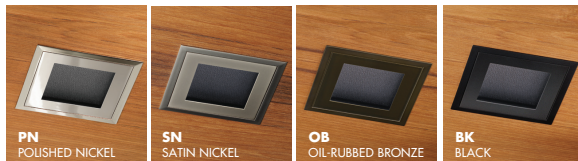

Trim Assembly

- **FLS-LG-W** flanged trim designed for wood, stone, acoustic tile, or sheetrock ceilings.
- 4" trim plate with minimal 2 3/4" aperture installs flush with the finished ceiling.
- Field adjustable to accommodate ceiling thickness between 1/2" - 1 1/2".
- Die-cast from Zinc alloy for maximum strength, stability, and corrosion resistance.
- Unique magnetic trim plate is removable without marring finishes.
- 4 3/4" wide flanged trim overlaps 4 3/8" ceiling cutout. Height and rotation can be adjusted before or after ceiling installation.
- Features +/- 3° rotational adjustment for squaring trim to other fixtures or nearby walls.
- Works with all Number Eight 800 Series housings.
- Includes Solite soft focus lens standard. Available with other lens options or without lens. **All lensed trim plates are rated for use in dry, damp, or wet locations (covered ceiling applications only).**
- Available in many designer finishes including: White, Polished Nickel**, Satin Nickel**, Oil-Rubbed Bronze**, and Black**.

****Lot variations in specialty finishes may occur. Ordering ALL trim kits at the same time is recommended to minimize variations in finishes.**

PRODUCT SPECIFIER/PRODUCT ORDER NUMBER

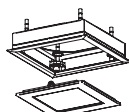
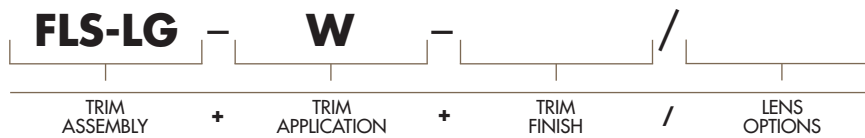

FLS-LG
4" SQUARE trim plate w/ 2 3/4" square aperture installs flush with 4 3/4" FLANGED trim

Solite soft focus lens installed standard

W
WOOD/STONE/ACOUSTIC TILE/SHEETROCK ceiling applications (1/2" min - 1 1/2" max)

WH
WHITE - Field paintable to match ceiling finish

PN
POLISHED NICKEL*

SN
SATIN NICKEL*

OB
OIL-RUBBED BRONZE*

BK
BLACK*

*Specially finish. Additional lead time required.

NL
NO LENS installed in trim plate

CL
CLEAR LENS installed in trim plate*

WW
WALL WASH lens installed in trim plate*

*Lensed trim plate rated for use in DRY, DAMP, or WET locations (covered ceiling applications only).

TRIM ASSEMBLY CROSS SECTION DETAIL

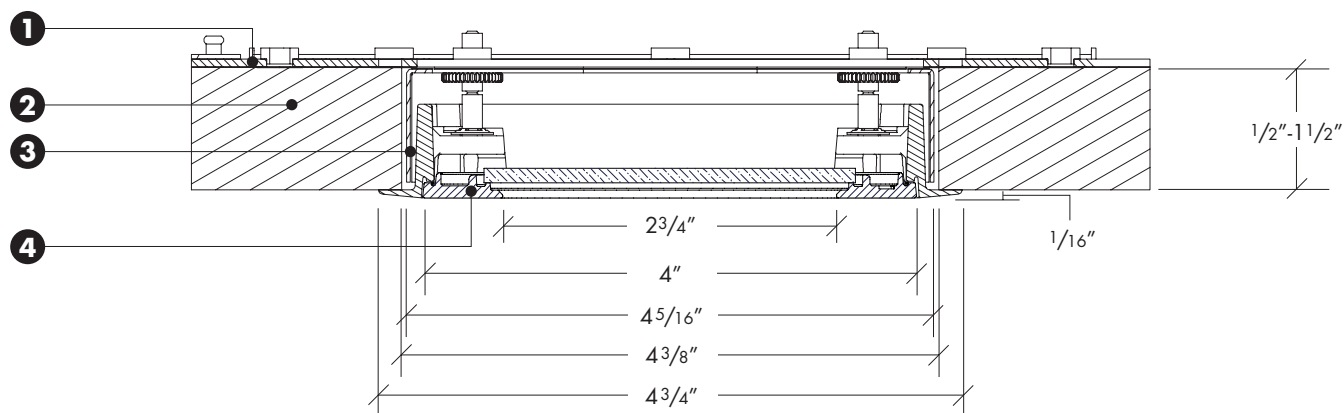

- 1) Housing**
- 2) Wood/Stone/Acoustic Tile Ceiling Material** – Accommodates all thickness from 1/2" to 1 1/2".
- 3) Flanged Flush Trim Kit** – 4 3/4" wide flanged trim overlaps 4 3/8" ceiling cut out. Height and rotation can be adjusted before or after ceiling installation.
- 4) Trim Plate** – Features unique magnetic attachments. Mounts flush to finished ceiling. Includes Solite soft focus lens standard.

Note: Cross sections are for illustration purposes only. Refer to W-Series trim installation instructions for complete installation details.