

# TRIM: FS-LG-W - SEAMLESS SERIES™/SQUARE

4" TRIM, 2 3/4" APERTURE FOR WOOD/STONE CEILING APPLICATIONS

Project Name	
Date	Type
Prepared By	
Comments	
Catalog #	<b>FS - LG - W - /</b>



**eight**  
LIGHTING

526 Portal Street  
Cotati, CA 94931  
USA  
P 707.794.0888  
F 707.795.4379  
www.8lighting.com

All No. 8 Lighting fixtures and components are UL/CSA listed. U.S. Patents Pending on the Seamless™ and Inset™ Series trims as well as the type A Lamp Module. No. 8 Lighting reserves the right to change details of design, materials, and finish.

© 2017 No. 8 Lighting  
Doc # 91313-11.1



## PRODUCT FEATURES

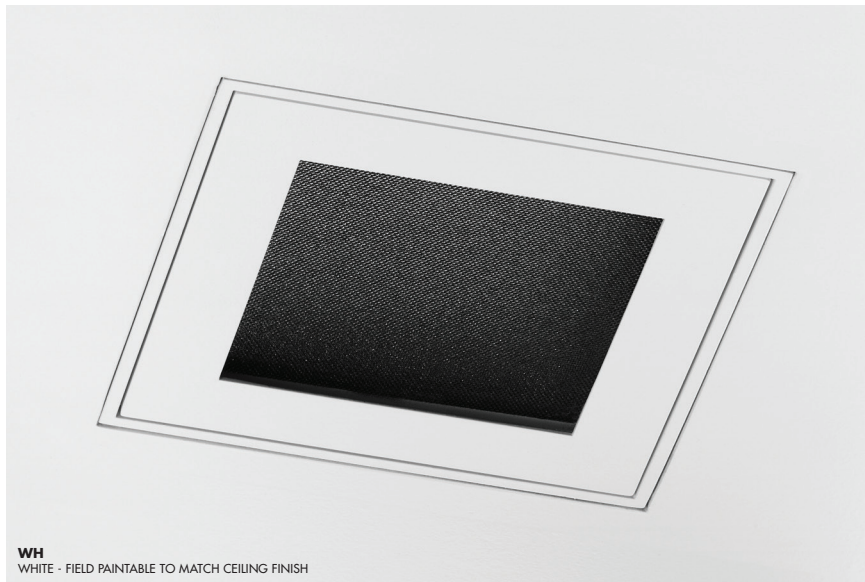

**WH**  
WHITE - FIELD PAINTABLE TO MATCH CEILING FINISH

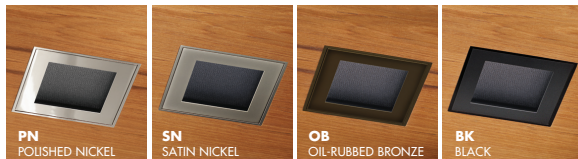

### Trim Assembly

- **FS-LG-W** trim designed for flush installation into wood/stone ceilings.
- 4" trim plate with minimal 2 3/4" aperture installs flush with the finished ceiling.
- Field adjustable to accommodate ceiling thickness between 1/2" - 1 1/2".
- Die-cast from Zinc alloy for maximum strength, stability, and corrosion resistance.
- Unique magnetic trim plate is removable without marring finishes.
- 4 5/16" wide trim installs flush within 4 3/8" ceiling cut out.
- Features +/- 3° rotational adjustment for squaring trim to other fixtures or nearby walls.
- Can be installed before or after ceiling installation.
- Works with all Number Eight 800 Series housings.
- Includes Solite soft focus lens standard. Available with other lens options or without lens. **All lensed trim plates are rated for use in dry, damp, or wet locations (covered ceiling applications only).**
- Available in many designer finishes including: White, Polished Nickel\*\*, Satin Nickel\*\*, Oil-Rubbed Bronze\*\*, and Black\*\*.

**\*\*Lot variations in specialty finishes may occur. Ordering ALL trim kits at the same time is recommended to minimize variations in finishes.**

## PRODUCT SPECIFIER/PRODUCT ORDER NUMBER

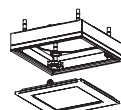
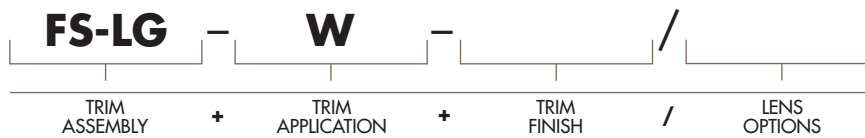

**FS-LG**  
Trim FLUSH w/ finished ceiling  
4" SQUARE flangeless w/ 2 3/4" square aperture  
**Solite soft focus lens installed standard**

**W**  
WOOD/STONE ceiling applications (1/2" min - 1 1/2" max)

**WH**  
WHITE - Field paintable to match ceiling finish

**PN**  
POLISHED NICKEL\*

**SN**  
SATIN NICKEL\*

**OB**  
OIL-RUBBED BRONZE\*

**BK**  
BLACK\*

\*Specialty finish. Additional lead time required.

**NL**  
NO LENS installed in trim plate

**CL**  
CLEAR LENS installed in trim plate\*

**WW**  
WALL WASH lens installed in trim plate\*

\*Lensed trim plate rated for use in DRY, DAMP, or WET locations (covered ceiling applications only).

TRIM ASSEMBLY CROSS SECTION DETAIL

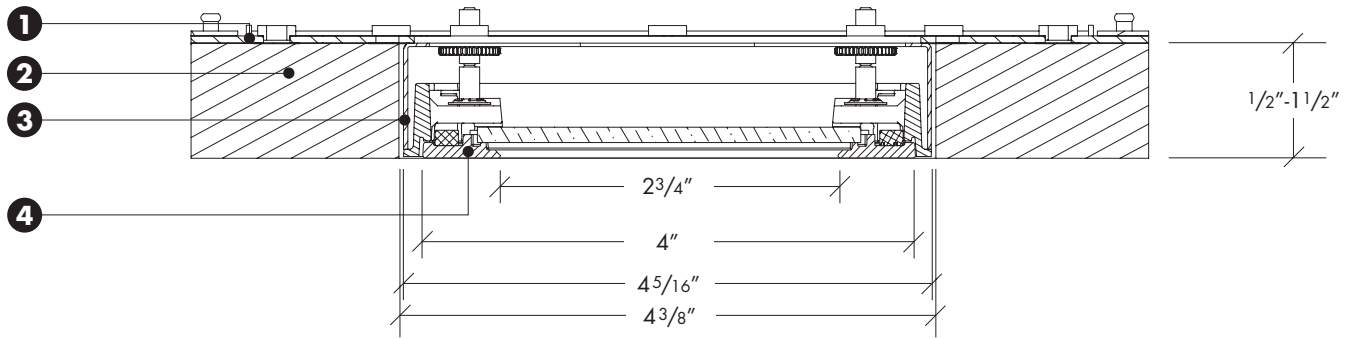

- 1) Housing**
- 2) Wood/Stone Ceiling Material** – Accommodates all thickness from 1/2" to 1 1/2".
- 3) Flush Trim Kit** – 4 5/16" wide trim installs flush within 4 3/8" ceiling cut out. Height and rotation may be adjusted before or after ceiling installation.
- 4) Trim Plate** – Features unique magnetic attachments. Mounts flush to finished ceiling. Includes Solite soft focus lens standard.

**Note:** Cross sections are for illustration purposes only. Refer to W-Series trim installation instructions for complete installation details.